

Report on OSU Opto-Pack Prototypes

K.K. Gan

The Ohio State University

June 11, 2001

Outline

- Introduction
- Result on VCSEL opto-pack prototypes
- Result on PIN opto-pack prototypes
- Result on temperature cycling
- Result on test with opto-boards
- Production Plan
- Conclusions

OSU Design

- connector concept design
 - ☆ use precisely fabricated cap and base for alignment
 - ☆ simple two-piece design for mass production
- cap
 - ☆ holes for fibers
- base
 - ☆ deposit gold traces for wire bonding, VCSEL and PIN placements

VCSEL Opto-Pack

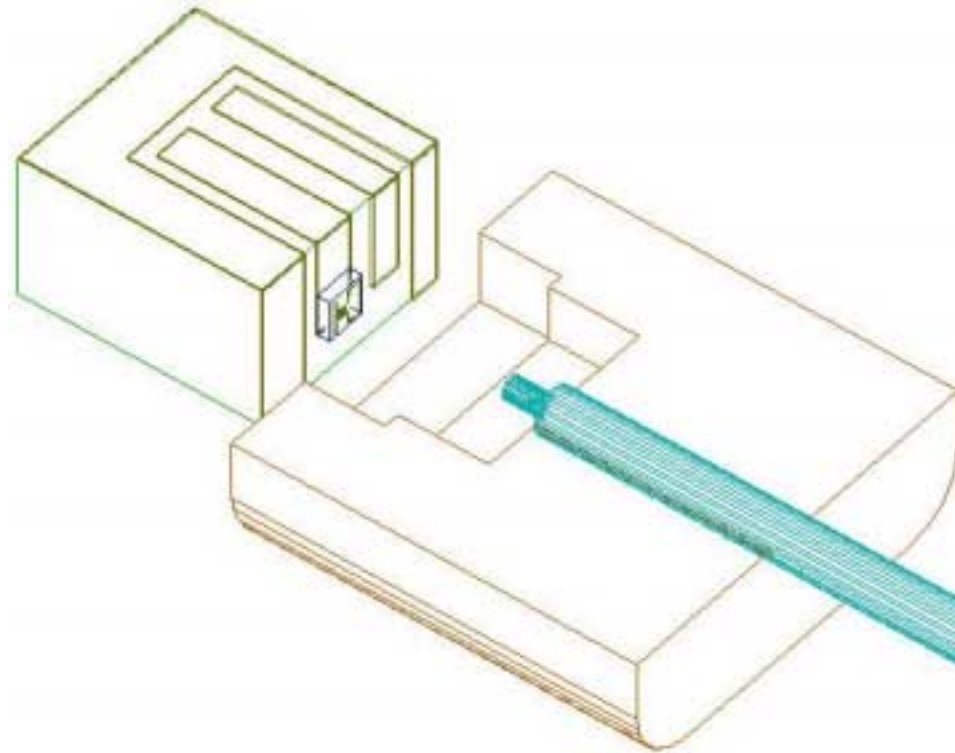

PIN Opto-Pack

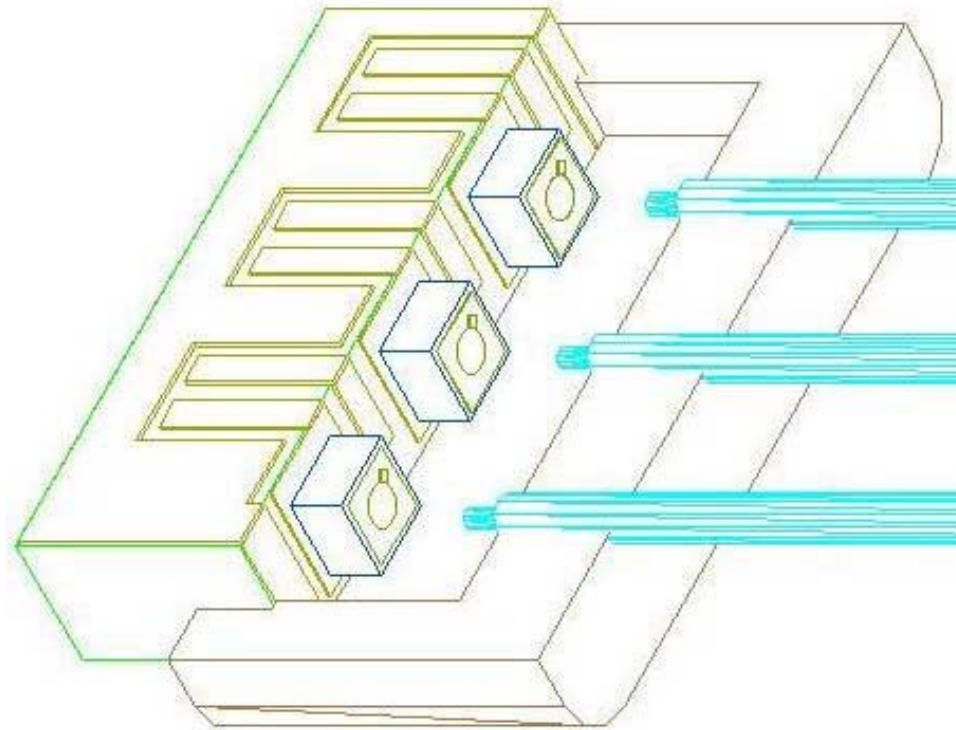

Cap and Base Prototypes

- produced caps and bases with rounded corners using machinable ceramic
 - ☆ material tested: aluminum silicate and macor
 - ☆ difficult to obtain consistent precision
 - ⇒ redesign base with square corners for ease of fabrication by Hybrid-Tek
 - ☆ alumina sheet ground to proper thickness and cut into strips
 - ☆ strips cut into bases by American Dicing
 - ☆ can produce bases with precision within specification
 - ☆ 3D traces have good connectivity (~ 94%)
 - ⇒ fabricate cap with Ultem (polyetherimide) for radiation tolerance (10 Grad)
 - ☆ use manual micro mold injection to save development time
 - ☆ can fabricate ~ 10 caps per hour

VCSEL Base Width

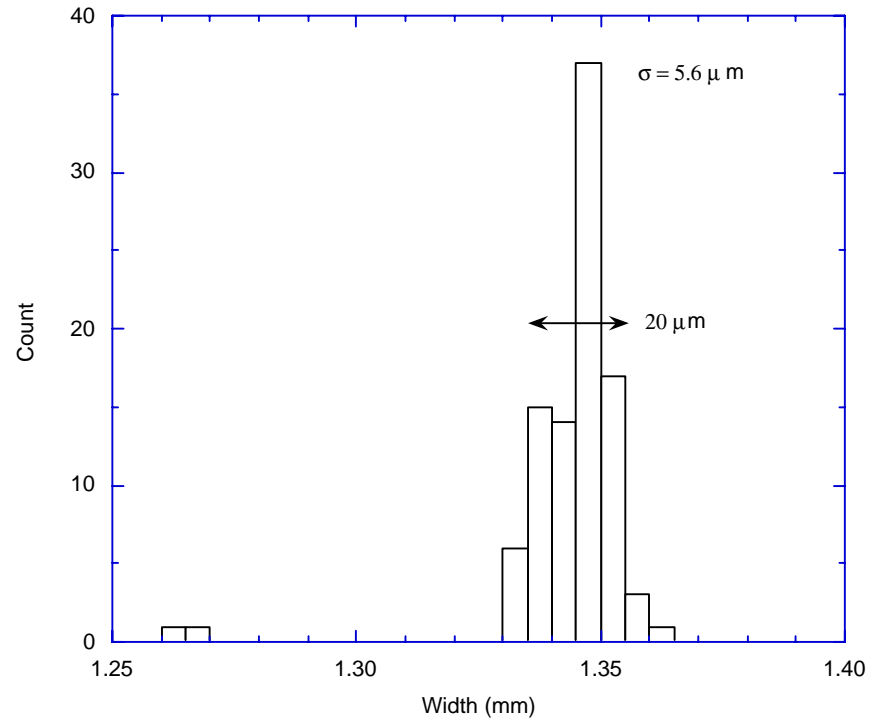

- accept ~ 90% of bases

VCSEL Placement

- VCSEL needs to be placed with a precision of 10 μm
 - ⇒ use precisely fabricate jig
 - ☆ precision base slot slightly larger than base
 - ☆ precisely located pocket for VCSEL
 - ☆ pocket slightly larger than VCSEL
 - ⇒ 3 contributions to placement uncertainty
 - ⇒ 12 out 18 bases fabricated satisfy power coupling spec.
 - ⇒ new VCSEL placement scheme

New VCSEL Placement Scheme

- measure location of pin in cap mold using comparator
 - ⇒ place VCSEL at expected fiber location
 - ☆ put base on comparator
 - ☆ move cross-hair to expected fiber location based on measured width
 - ☆ move VCSEL to cross-hair with micro-manipulator
 - ◆ operation time: ~ 5 minutes
- expect more precise pin location with CMM measurement
 - ⇒ should further improve coupled power

Cap Fabrication Mold



Fiber Placement Jig

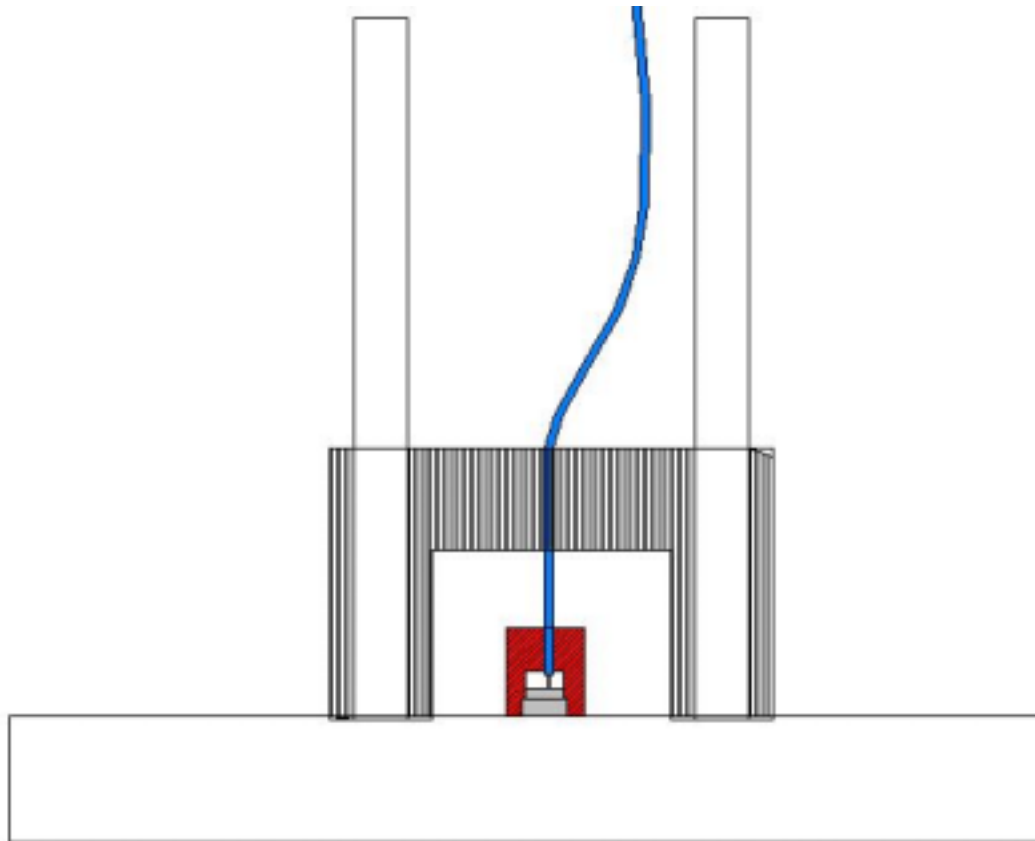

Cap with Precisely Fabricated Cavity



Base with VCSEL

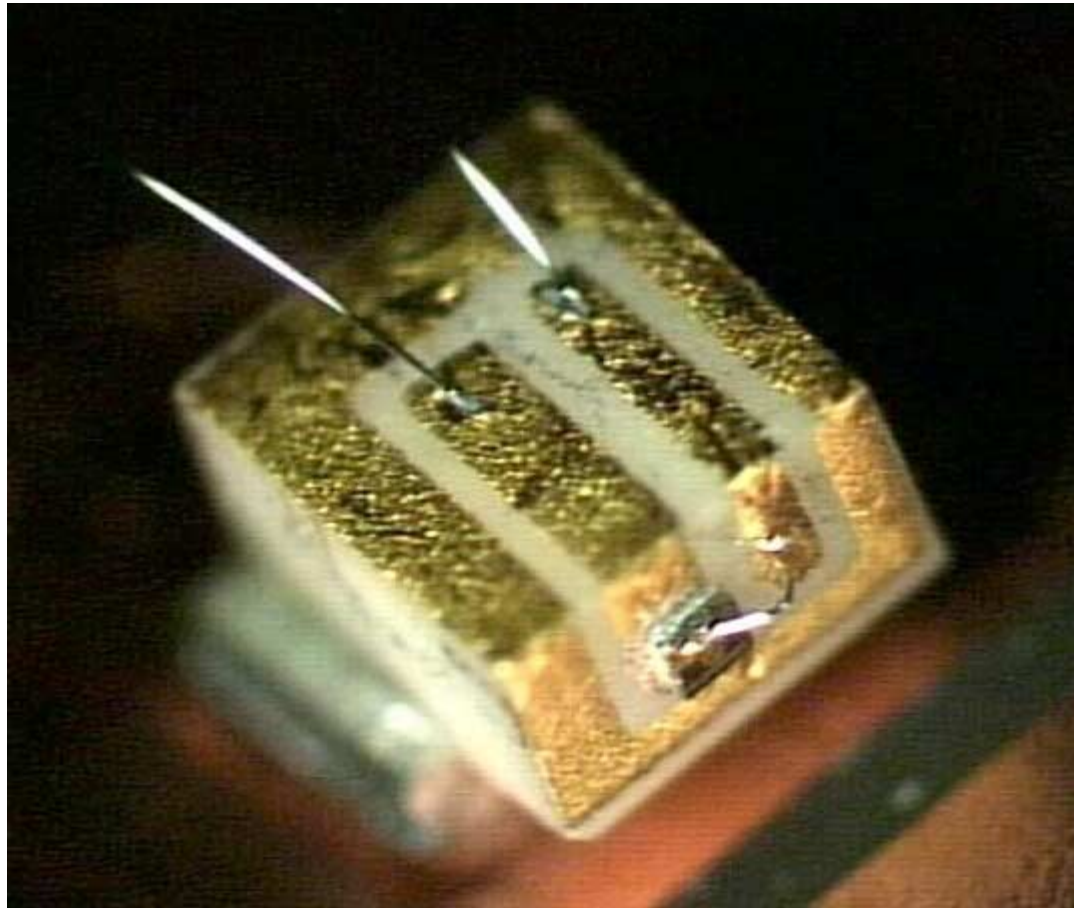

Completed VCSEL Opto-Pack

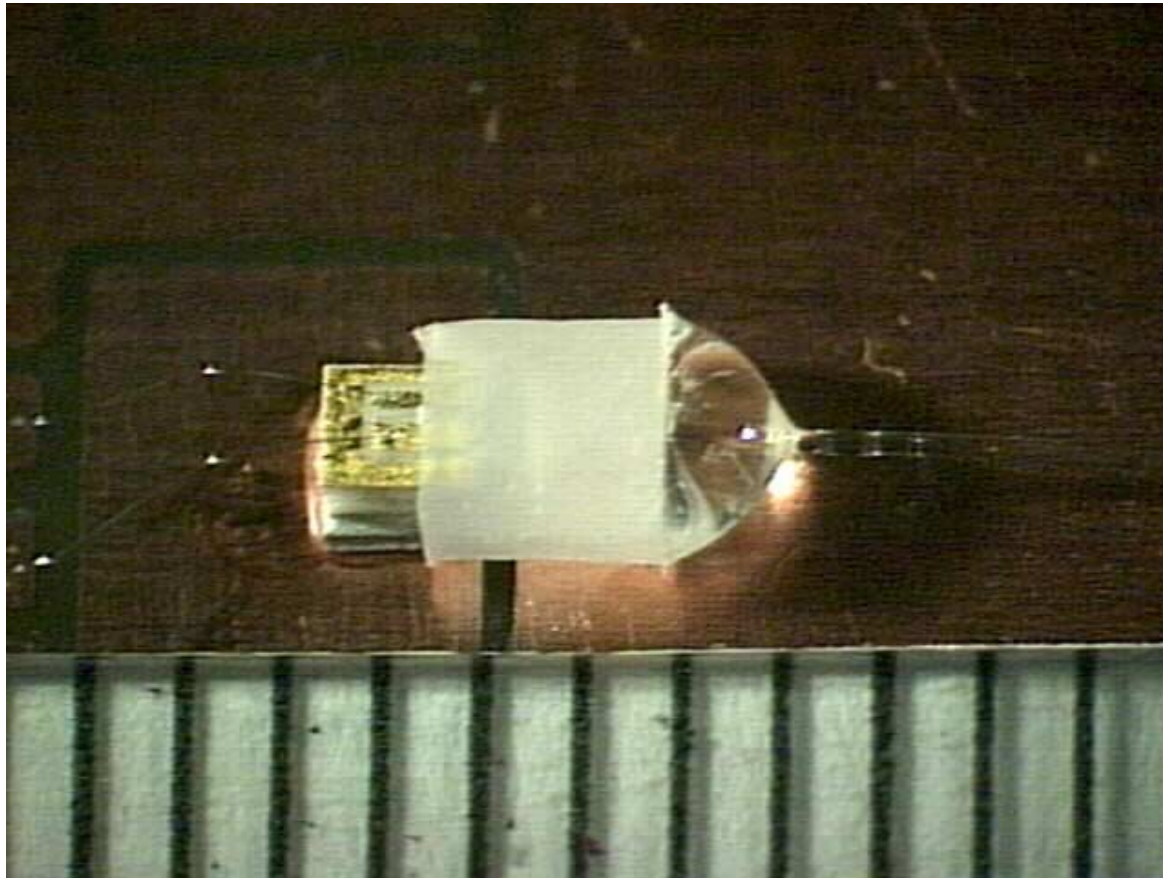

1 mm

Coupled VCSEL Power @ 10 mA

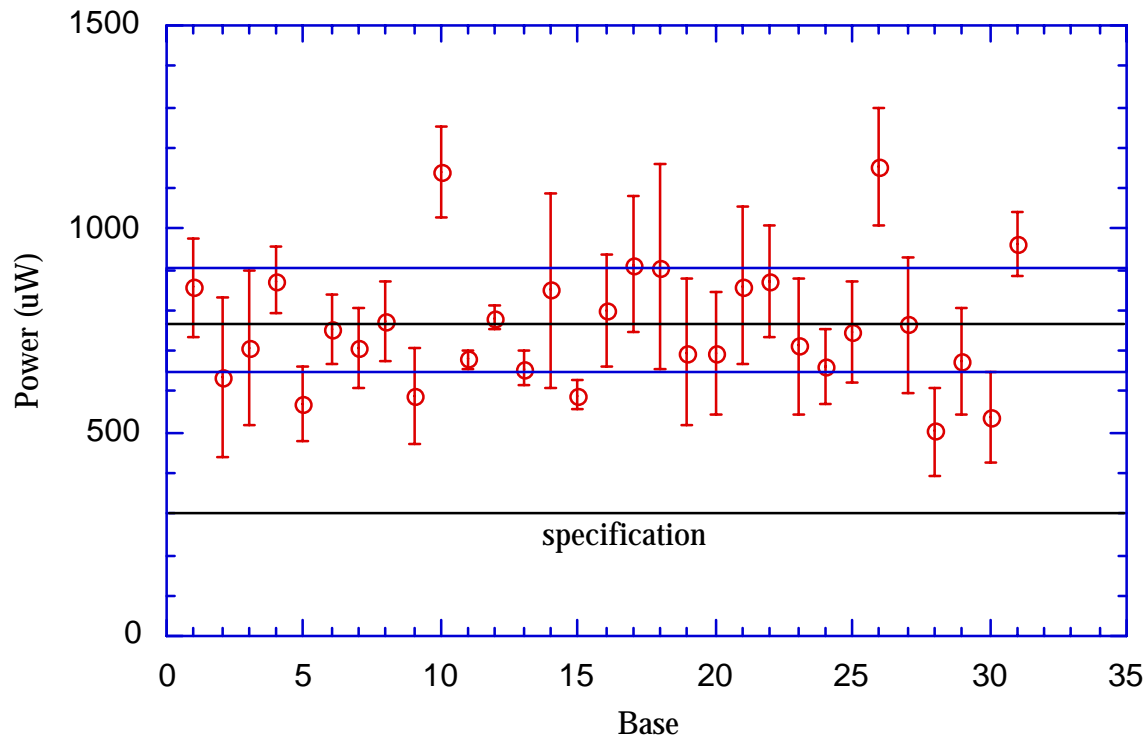

- all VCSEL opto-packs have coupled power well above spec.

Coupled VCSEL Power vs Usage

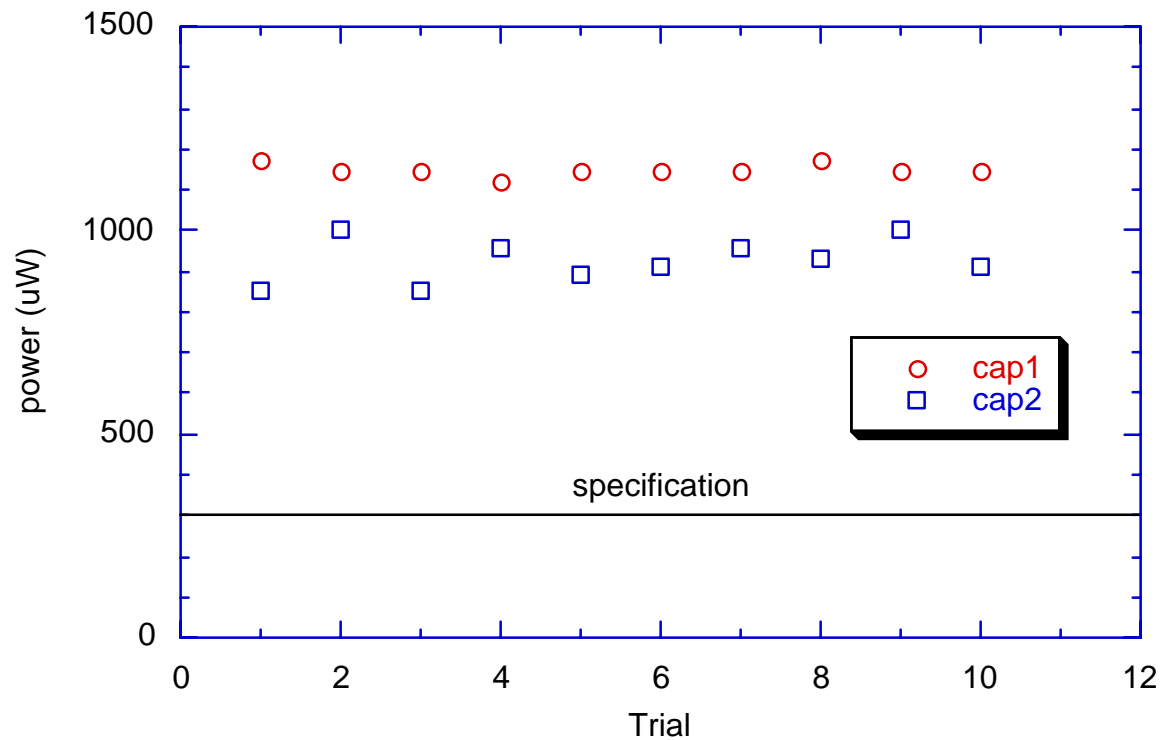

- caps can be used multiple times

Coupled VCSEL Power vs Usage

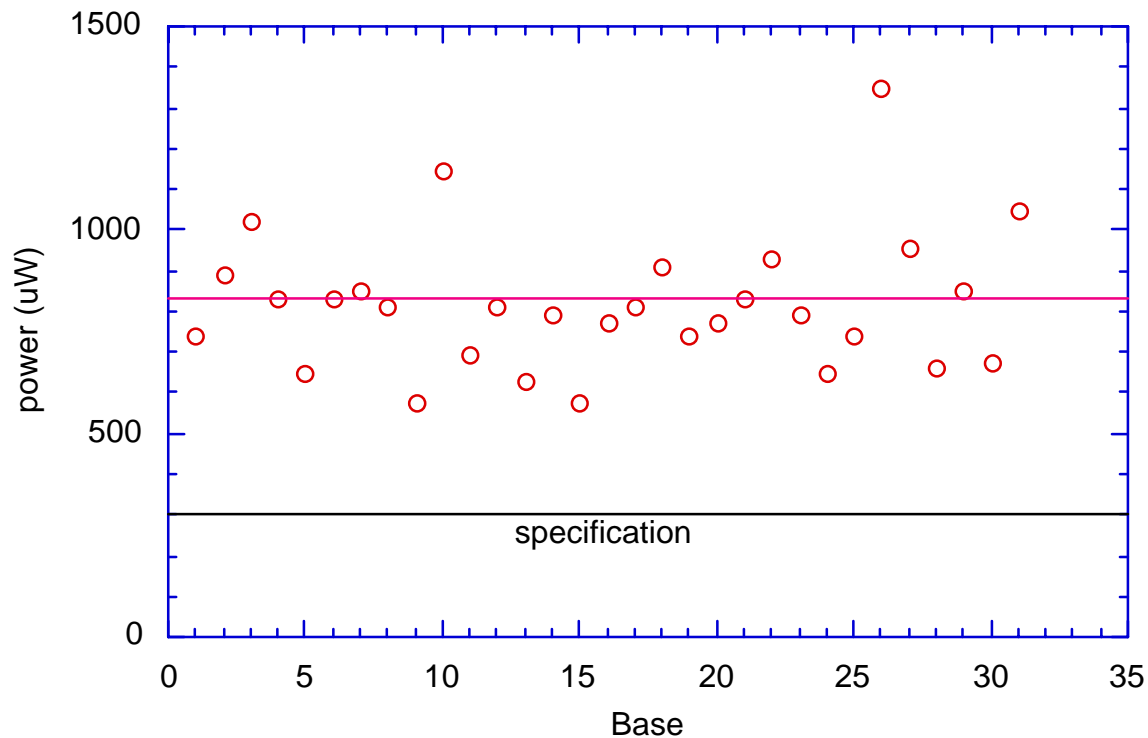

- same cap gives good power on 31 bases
- ⇒ cap is reusable and inter-changeable

VCSEL Waveform

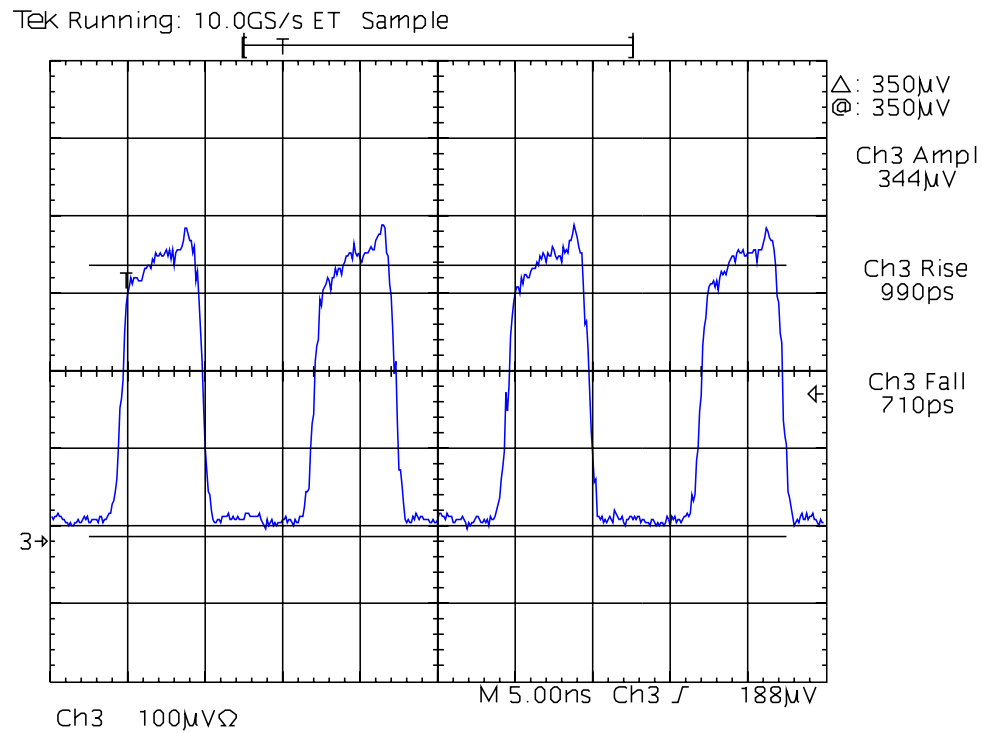

- VCSEL opto-pack has fast rise and fall times

Temperature Cycling

- 10 VCSEL opto-packs were temperature cycling:
 - ☆ ~ 300 cycles between -10⁰C and 60⁰C
 - ⇒ no degradation observed

PIN Opto-pack Responsivity

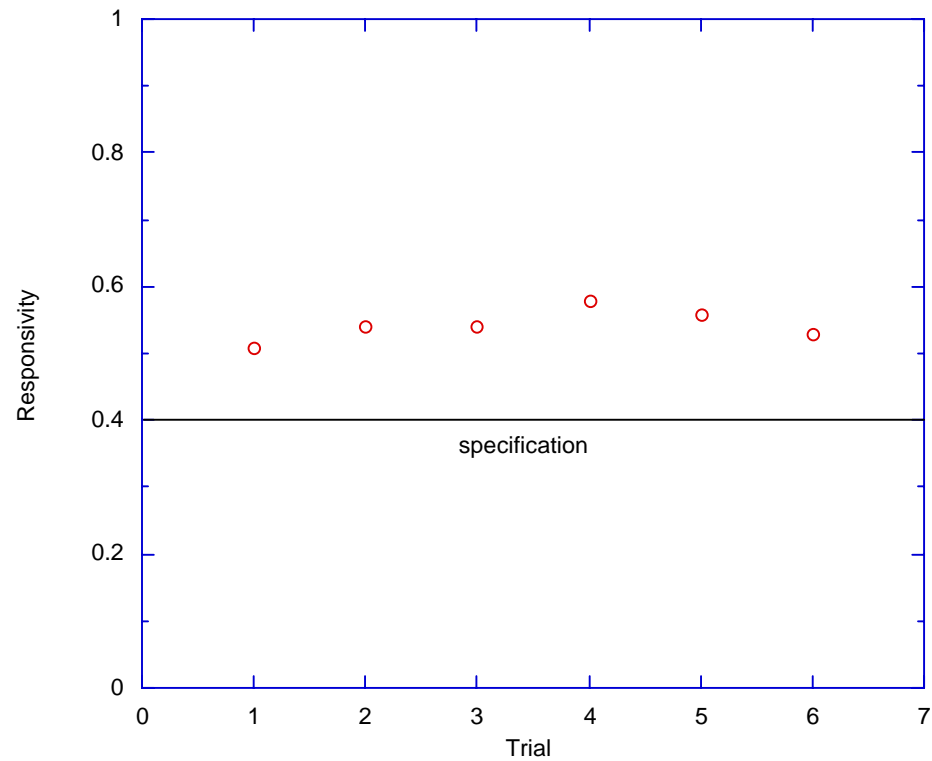

- PIN opto-pack responsivity is above spec.

BER of Opto-packs on Opto-board

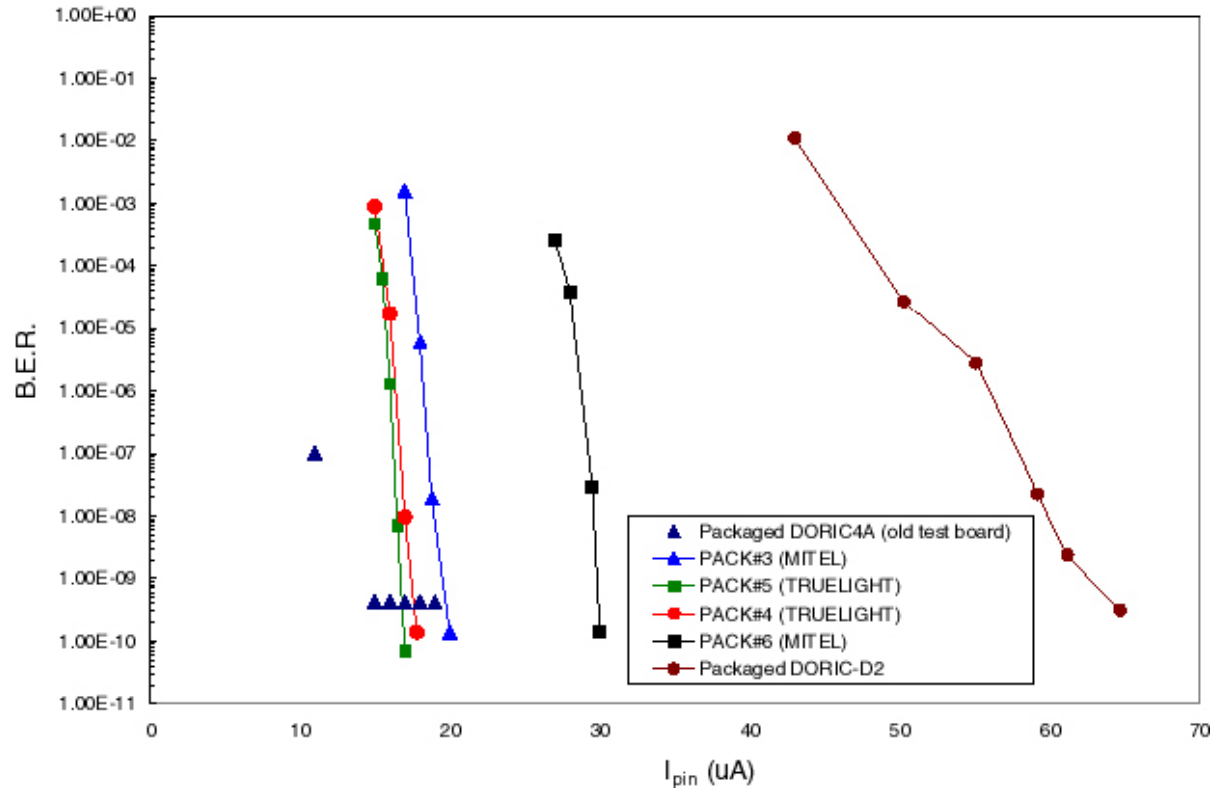

- opto-packs can run with low PIN current

Pro and Con of OSU Design

- disadvantages
 - ☆ need to fabricate more packages
 - ◆ extra time: 2000 caps x 10 min = 2 months of manpower
- advantages:
 - ☆ limited number of PIN/VCSEL per package to reduce loss
 - ☆ select VCSEL opto-packs of similar coupled power for appropriate I_{set}
 - ☆ opto-board without 21 long fibers is much easier to handle
 - ☆ cure epoxy on opto-board in oven without fibers for die replacement
 - ☆ cap with fibers can be attached to package at end of module assembly

Production Plan

- can transfer technology to any interested institution
 - ☆ OSU will provide jigs
- manpower need
 - ☆ assuming 30 minutes per VCSEL or PIN
 - ⇒ need 1.5 manpower-year to fabricate 3000 packages

Summary on OSU Opto-pack Prototype

- OSU prototype program successfully completed
 - ☆ can fabricate VCSEL opto-packs with good coupled power
 - ☆ can fabricate PIN opto-packs with good responsivity
 - ☆ opto-packs can run at low PIN current
- remountable caps offer maximum flexibility in opto-board assembly and repair