

February 15, 2000 (Version 2.1)

Package Information

Inches vs. Millimeters

The JEDEC standards for PLCC, CQFP, and PGA packages define package dimensions in inches. The lead spacing is specified as 25, 50, or 100 mils (0.025", 0.050" or 0.100").

The JEDEC standards for PQFP, HQFP, TQFP, and VQFP packages define package dimensions in millimeters. These

packages have a lead spacing of 0.5 mm, 0.65 mm, or 0.8 mm.

Because of the potential for measurement discrepancies, this Data Book provides measurements in the controlling standard only, either inches or millimeters. (See [Table 1](#) for package dimensions.)

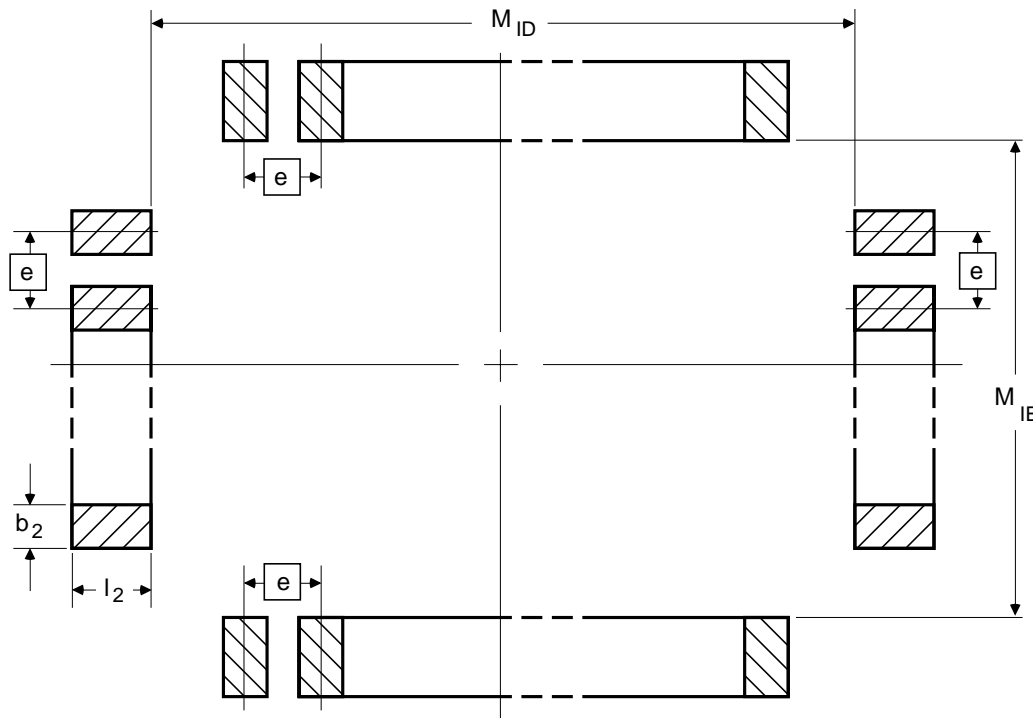

Figure 1: EIA Standard Board Layout of Soldered Pads for QFP Devices

Table 1: Dimensions for Xilinx Quad Flat Packs⁽¹⁾

Dim.	VQ44	VQ64	PQ100	HQ160 PQ160	HQ208 PQ208	VQ100 TQ100	TQ144	TQ176	HQ240 PQ240	HQ304
M_{ID}	9.80	9.80	20.40	28.40	28.20	13.80	19.80	23.80	32.20	40.20
M_{IE}	9.80	9.80	14.40	28.40	28.20	13.80	19.80	23.80	32.20	40.20
e	0.80	0.50	0.65	0.65	0.50	0.50	0.50	0.50	0.50	0.50
b_2	0.4 - 0.6	0.3 - 0.4	0.3 - 0.5	0.3 - 0.5	0.3 - 0.4	0.3 - 0.4	0.3 - 0.4	0.3 - 0.4	0.3 - 0.4	0.3 - 0.4
l_2	1.60	1.60	1.80 ²	1.80	1.60	1.60	1.60	1.60	1.60	1.60

Notes: 1. Dimensions in millimeters
2. For 3.2 mm footprint per MS022, JEDEC Publication 95.

Suggested Board Layout of Soldered Pads for BGA, CS and FG Packages

Suggested Board Layout of Soldered Pads for BGA, CS and FG Packages

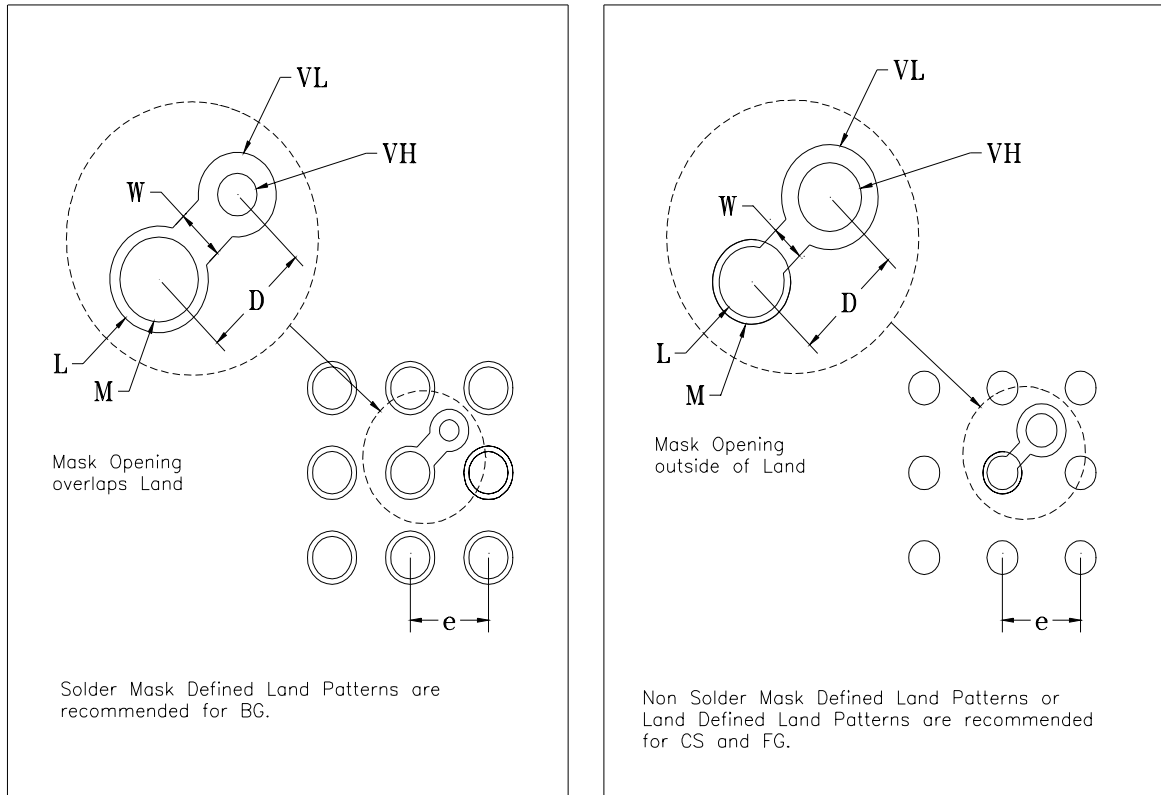

Figure 2: Suggested Board Layout of Soldered Pads for BGA, CS and FG Packages

Table 2: Soldering Dimensions for BG, CS, and FG Packages

	BG225	*BG256	BG352	BG432	BG560	CS48	CS144	CS280
Solder Land (L) diameter	0.89	0.79	0.79	0.79	0.79	0.33	0.33	0.33
Opening in Solder Mask (M) diameter	0.65	0.58	0.58	0.58	0.58	0.44	0.44	0.44
Solder (Ball) Land Pitch (e)	1.5	1.27	1.27	1.27	1.27	0.8	0.8	0.8
Line Width between Via and Land (w)	0.3	0.3	0.3	0.3	0.3	0.13	0.13	0.13
Distance between Via and Land (D)	1.06	0.9	0.9	0.9	0.9	0.56	0.56	0.56
Via Land (VL) diameter	0.65	0.65	0.65	0.65	0.65	0.51	0.51	0.51
Through Hole (VH) diameter	0.3	0.3	0.3	0.3	0.3	0.25	0.25	0.25
Pad Array	Full	-	-	-	-	-	-	-
Matrix or External Row	15 x 15	20 x 20	26 x 26	31 x 31	33 x 33	7 x 7	13 x 13	19 x 19
Periphery rows	-	4	4	4	5	3	4	5
	FG256	FG456	FG556	FG676	FG680	FG860	FG900	FG1156
Solder Land (L) diameter	0.4	0.4	0.4	0.4	0.4	0.4	0.4	0.4
Opening in Solder Mask (M) diameter	0.5	0.5	0.5	0.5	0.5	0.5	0.5	0.5
Solder (Ball) Land Pitch (e)	1.0	1.0	1.0	1.0	1.0	1.0	1.0	1.0
Line Width between Via and Land (w)	0.13	0.13	0.13	0.13	0.13	0.13	0.13	0.13
Distance between Via and Land (D)	0.7	0.7	0.7	0.7	0.7	0.7	0.7	0.7
Via Land (VL) diameter	0.61	0.61	0.61	0.61	0.61	0.56	0.61	0.61
Through Hole (VH), diameter	0.3	0.3	0.3	0.3	0.3	0.3	0.3	0.3
Pad Array	Full	Full	-	Full	-	-	Full	Full
Matrix or External Row	16 x 16	22 x 22	30 x 30	26 x 26	39 x 39	42 x 42	30 x 30	34 x 34

Table 2: Soldering Dimensions for BG, CS, and FG Packages

Periphery rows	-	-	7	-	5	6	-	-
----------------	---	---	---	---	---	---	---	---

Cavity Up or Cavity Down

Most Xilinx devices attach the die against the inside bottom of the package (the side that does not carry the Xilinx logo). This is called cavity-up, and has been the standard IC assembly method for over 25 years. This method does not provide the best thermal characteristics. Pin Grid Arrays (greater than 130 pins) and Ceramic Quad Flat Packs are assembled "Cavity Down", with the die attached to the inside top of the package, for optimal heat transfer to the ambient air.

For most packages this information does not affect how the package is used because the user has no choice in how the package is mounted on a board. For Ceramic Quad Flat Pack (CQFP) packages however, the leads can be formed to either side. Therefore, for best heat transfer to the surrounding air, CQFP packages should be mounted with the logo up, facing away from the PC board.

Clockwise or Counterclockwise

The orientation of the die in the package and the orientation of the package on the PC board affect the PC board layout. PLCC and PQFP packages specify pins in a counterclockwise direction, when viewed from the top of the package (the surface with the Xilinx logo). PLCCs have pin 1 in the center of the beveled edge while all other packages have pin 1 in one corner, with one exception: The 100- and 165-pin CQFPs (CB100 and CB164) for the XC3000 devices have pin 1 in the center of one edge.

CQFP packages specify pins in a clockwise direction, when viewed from the top of the package. The user can make the pins run counterclockwise by forming the leads such that the logo mounts against the PC board. However, heat flow to the surrounding air is impaired if the logo is mounted down.

Thermal Management

Modern high speed logic devices consume an appreciable amount of electrical energy. This energy invariably turns into heat. Higher device integration drives technologies to produce smaller device geometry and interconnections. With smaller chip sizes and higher circuit densities, heat generation on a fast switching CMOS circuit can be very significant. The heat removal needs for these modern devices must be addressed.

Managing heat generation in a modern CMOS logic device is an industry-wide pursuit. However, unlike the power needs of a typical Application Specific Integrated Circuit (ASIC) gate array, the power requirements for FPGAs are not determined as the device leaves the factory. Designs vary in power needs.

There is no way of anticipating the power needs of an FPGA device short of depending on compiled data from previous designs. For each device type, primary packages are chosen to handle "typical" designs and gate utilization requirements. For the most part the choice of a package as the primary heat removal casing works well.

Occasionally designers exercise an FPGA device, particularly the high gate count variety, beyond "typical" designs. The use of the primary package without enhancement may not adequately address the device's heat removal needs. Heat removal management through external means or an alternative enhanced package should be considered.

Removing heat ensures the functional and maximum design temperature limits are maintained. The device may go outside the temperature limits if heat build up becomes excessive. As a consequence, the device may fail to meet electrical performance specifications. It is also necessary to satisfy reliability objectives by operating at a lower temperature. Failure mechanisms and the failure rate of devices depend on device operating temperature. Control of the package and the device temperature ensures product reliability.

Package Thermal Characterization Methods & Conditions

Method and Calibration

Xilinx uses the indirect electrical method for package thermal resistance characterization. The forward-voltage drop of an isolated diode residing on a special test die is calibrated at constant forcing current of 0.520mA with respect to temperature over a correlation temperature range of 22°C to 125°C (degree Celsius). The calibrated device is then mounted in an appropriate environment (still air, forced convection, circulating FC-40, etc.) Depending on the package, between 0.5 to 4 watts of power (Pd) is applied. Power (Pd) is applied to the device through diffused resistors on the same thermal die. The resulting rise in junction temperature is monitored with the forward-voltage drop of the precalibrated diode. Typically, three identical samples are tested at each data point. The reproducibility error in the set-up is within 6%.

Definition of Terms

- T_J Junction Temperature — the maximum temperature on the die, expressed in °C (degree Celsius)
- T_A Ambient Temperature — expressed in °C.
- T_C The temperature of the package body taken at a defined location on the body. This is taken at the pri-

mary heat flow path on the package and represents the hottest part on the package — expressed in °C.

- T_I The isothermal fluid temperature when junction to case temperature is taken — expressed in °C.
- P_d The total device power dissipation — expressed in watts.

Junction-to-Reference General Setup

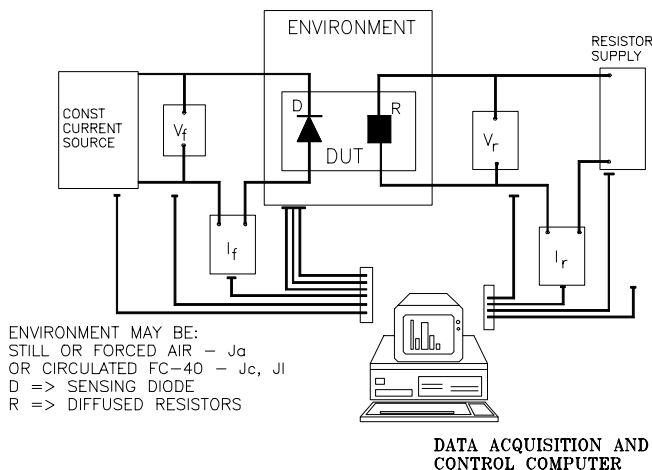

Figure 3: Thermal Measurement Set-Up (Schematic for Junction to Reference)

Junction-to-Case Measurement — Θ_{JC}

Θ_{JC} is measured in a 3M Flourinert (FC-40) isothermal circulating fluid stabilized at 25°C. The Device Under Test (DUT) is completely immersed in the fluid and initial stable conditions are recorded. P_d is then applied. Case temperature (T_C) is measured at the primary heat-flow path of the particular package. Junction temperature (T_J) is calculated from the diode forward-voltage drop from the initial stable condition before power was applied.

$$\Theta_{JC} = (T_J - T_C)/P_d$$

The junction-to-isothermal-fluid measurement (Θ_{Jl}) is also calculated from the same data.

$$\Theta_{Jl} = (T_J - T_I)/P_d$$

The latter data is considered as the ideal Θ_{JA} data for the package that can be obtained with the most efficient heat removal scheme. Other schemes such as airflow, heat-sinks, use of copper clad board, or some combination of all these will tend towards this ideal figure. Since this is not a widely used parameter in the industry, and it is not very realistic for normal application of Xilinx packages, the Θ_{Jl} data is not published. The thermal lab keeps such data for package comparisons.

Junction-to-Ambient Measurement — Θ_{JA}

Θ_{JA} is measured on FR4 based PC boards measuring 4.5" x 6.0" x .0625" (114.3mm x 152.4mm x 1.6mm) with edge connectors. There are two main board types.

Type I, 2L/0P board, is single layer with 2 signal planes (one on each surface) and no internal Power/GND planes. The trace density on this board is less than 10% per side. Type II, the 4L/2P board, has 2 internal copper planes (one power, one ground) and 2 signal trace layers on both surfaces.

Data may be taken with the package mounted in a socket or with the package mounted directly on the board. Socket measurements typically use the 2L/0P boards. SMT devices may use either board. Published data always reflects the board and mount conditions used.

Data is taken at the prevailing temperature and pressure conditions (22°C to 25°C ambient). The board with the DUT is mounted in a cylindrical enclosure. The power application and signal monitoring are the same as Θ_{JC} measurements. The enclosure (ambient) thermocouple is substituted for the fluid thermocouple and two extra thermocouples brought in to monitor room and board temperatures. The junction to ambient thermal resistance is calculated as follows:

$$\Theta_{JA} = (T_J - T_A)/P_d$$

The setup described herein lends itself to the application of various airflow velocities from 0 - 800 Linear Feet per Minute (LFM), i.e., 0 - 4.06 m/s. Since the board selection (copper trace density, absence or presence of ground planes, etc.) affects the results of the thermal resistance, the data from these tests shall always be qualified with the board mounting information.

Data Acquisition and Package Thermal Database

Xilinx gathers data for a package type in die sizes, power levels and cooling modes (air flow and sometimes heatsink effects) with a Data Acquisition and Control system (DAS). The DAS controls the power supplies and other ancillary equipment for hands-free data taking. Different setups within the DAS software are used to run calibration, Θ_{JA} , Θ_{JC} , fan tests, as well as the power effect characteristics of a package.

A package is characterized with respect to the major variables that influence the thermal resistance. The results are stored in a database. Thermal resistance data is interpolated as typical values for the individual Xilinx devices that are assembled in the characterized package. Table 3 shows the typical values for different packages. Specific device data may not be the same as the typical data. However, the data will fall within the given minimum and maximum ranges. The more widely used packages will have a wider range. Customers may contact the Xilinx application group for specific device data.

Table 3: Summary of Thermal Resistance for Packages

PKG-CODE	Θ_{JA} still air (Max)	Θ_{JA} still air (Typ)	Θ_{JA} still air (Min)	Θ_{JA} 250 LFM (Typ)	Θ_{JA} 500 LFM (Typ)	Θ_{JA} 750 LFM (Typ)	Θ_{JC} (Typ)	Comments
	°C/Watt	°C/Watt	°C/Watt	°C/Watt	°C/Watt	°C/Watt	°C/Watt	
BG225	37	30	24	19	17	16	3.3	Various
BG256	32	29	24	19	17	16	3.2	4L/2P-SMT
BG352	14	12	10	8	7	6	0.8	4L/2P-SMT
BG432	13	11	9	8	6	6	0.8	4L/2P-SMT
BG560	10	9	8	7	6	5	0.8	Estimated
CB100	44	41	38	25	19	17	5.1	Socketed
CB164	29	26	25	17	12	11	3.6	Socketed
CB196	25	24	24	15	11	10	1.8	Socketed
CB228	19	18	17	11	8	7	1.3	Socketed
CS48		45						Estimated
CS144		65						Estimated
DD8	114	109	97	90	73	60	8.2	Socketed
HQ160	14	14	14	10	8	7	1.0	4L/2P-SMT
FG256	27	25	23	21	20	19	3.9	4L/2P-SMT
FG456	19	18	17	14	13	13	1.5	4L/2P-SMT
FG556	14	14	14	10	9	9	0.8	4L/2P-SMT
FG676	17	17	17	13	12	12	0.9	4L/2P-SMT
FG680	11	11	10	8	6	6	0.9	4L/2P-SMT
FG860	10	10	10	7	6	5	0.8	4L/2P-SMT
FG900	14	14	14	10	9	9	0.8	Estimated
FG1156	14	13	13	10	9	9	0.8	Estimated
HQ208	15	14	14	10	8	7	1.7	4L/2P-SMT
HQ240	13	12	12	9	7	6	1.5	4L/2P-SMT
HQ304	11	11	10	7	5	5	0.9	4L/2P-SMT
HT144	-	10.9	-	7.3	5.7	5.0	0.9	4L/2P-SMT
HT176	-	16.0	-	-	-	-	2.0	Estimated
PC20	86	84	76	63	56	53	25.8	2L/0P-SMT
PC44	51	46	42	35	31	29	13.7	2L/0P-SMT
PC68	46	42	38	31	28	26	9.3	2L/0P-SMT
PC84	41	33	28	25	21	17	5.3	2L/0P-SMT
PD8	82	79	73	60	54	50	22.2	Socketed
PG84	37	34	31	24	18	16	5.8	Socketed
PG120	32	27	25	19	15	13	3.6	Socketed
PG132	32	28	24	20	17	15	2.8	Socketed
PG156	25	23	21	15	11	10	2.6	Socketed
PG175	25	23	20	14	11	10	2.6	Socketed
PG191	24	21	18	15	12	11	1.5	Socketed
PG223	24	20	18	15	12	11	1.5	Socketed
PG299	18	17	16	10	9	8	1.9	Socketed
PG411	16	15	14	9	8	7	1.2	Socketed
PG475	14	13	12	9	8	7	1.2	Socketed
PG559	-	12.00	-	-	-	-	-	Estimated
PP132	35	34	33	23	18	17	6.0	Socketed

Table 3: Summary of Thermal Resistance for Packages (Continued)

PKG-CODE	Θ_{JA} still air (Max)	Θ_{JA} still air (Typ)	Θ_{JA} still air (Min)	Θ_{JA} 250 LFM (Typ)	Θ_{JA} 500 LFM (Typ)	Θ_{JA} 750 LFM (Typ)	Θ_{JC} (Typ)	Comments
	°C/Watt	°C/Watt	°C/Watt	°C/Watt	°C/Watt	°C/Watt	°C/Watt	
PP175	29	29	28	19	15	13	2.5	Socketed
PQ100	35	33	32	29	28	27	5.5	4L/2P-SMT
PQ160	37	32	22	24	21	20	4.6	2L/0P-SMT
PQ208	35	32	26	23	21	19	4.3	2L/0P-SMT
PQ240	28	23	19	17	15	14	2.8	2L/0P-SMT
SO8	147	147	147	112	105	98	48.3	IEEE-(Ref)
TQ100	37	31	31	26	24	23	7.5	4L/2P-SMT
TQ144	35	32	30	25	21	20	5.3	4L/2P-SMT
TQ176	29	28	27	21	18	17	5.3	4L/2P-SMT
VO8	162	162	162	123	116	108	48.3	Estimated
VQ44	44	44	44	36	34	33	8.2	4L/2P-SMT
VQ64	44	41	39	34	32	31	8.2	4L/2P-SMT
VQ100	47	38	32	32	30	29	9.0	4L/2P-SMT

- Notes:
1. Maximum, typical and minimum numbers are based on numbers for all the devices in the specific package at the time of compilation. The numbers do not necessarily reflect the absolute limits of that packages. Specific device data should lie within the limits. Packages used for a broader spectrum of devices have a wider range in the table. Specific device data in a package may be obtained from the factory.
 2. Package configurations and drawings are in the package section of the data book.
 3. 2L/0P - SMT: the data is from a surface mount type I board -- no internal planes on the board.
 4. 4L/2P - SMT: the data is from a 4 layer SMT board incorporating 2 internal planes. Socketed data is taken in socket.
 5. Air flow is given Linear Feet per Minute (LFM). 500 LFM = 2.5 Meters per Second

Application of Thermal Resistance Data

Thermal resistance data gauges the IC package thermal performance. Θ_{JC} measures the internal package resistance to heat conduction from the die surface, through the die mount material to the package exterior. Θ_{JC} strongly depends on the package's heat conductivity, architecture and geometrical considerations.

Θ_{JA} measures the total package thermal resistance including Θ_{JC} . Θ_{JA} depends on the package material properties and such external conditions as convective efficiency and board mount conditions. For example, a package mounted on a socket may have a Θ_{JA} value 20% higher than the same package mounted on a 4 layer board with power and ground planes.

By specifying a few constraints, devices are ensured to operate within the intended temperature range. This also ensures device reliability and functionality. The system ambient temperature needs to be specified. A maximum T_J also needs to be established for the system. The following inequality will hold.

$$T_J(\text{max}) > \Theta_{JA} * Pd + T_A$$

The following two examples illustrates the use of this inequality.

Example 1:

The manufacturer's goal is $T_J(\text{max}) < 100^\circ\text{C}$
 A module is designed for a $T_A = 45^\circ\text{C}$ max.
 A XC3042 in a PLCC 84 has a $\Theta_{JA} = 32^\circ\text{C/watt}$.
 Given a XC3042 with a logic design with a rated power P_d of 0.75watt.

With this information, the maximum die temperature can be calculated as:

$$T_J = 45 + (32 \times .75) \implies 69^\circ\text{C}.$$

The system manufacturer's goal of $T_J < 100^\circ\text{C}$ is met.

Example 2:

A module has a $T_A = 55^\circ\text{C}$ max.
 The Xilinx XC4013E is in a PQ240 package (HQ240 is also considered).
 A XC4013E, in an example logic design, has a rated power of 2.50 watts. The module manufacturers goal is $T_J(\text{max.}) < 100^\circ\text{C}$.

Table 4 shows the package and thermal enhancement combinations required to meet the goal of $T_J < 100^\circ\text{C}$.

Table 4: Thermal Resistance for XC4013E in PQ240 and HQ240 Packages

Device Name	Package	Θ_{JA} still air	Θ_{JA} (250 LFM)	Θ_{JA} (500 LFM)	Θ_{JA} (750 LFM)	Θ_{JC}	Comments
XC4013E	PQ240	23.7	17.5	15.4	14.3	2.7	Cu, SMT 2L/0P
XC4013E	HQ240	12.5	8.6	6.9	6.2	1.5	4 Layer Board data

Notes: Possible Solutions to meet the module requirements of 100°C :
 1a. Using the standard PQ240; $T_J = 55 + (23.7 \times 2.50) \implies 114.25 \text{ }^\circ\text{C}$.
 1b. Using standard PQ240 with 250LFM forced air; $T_J = 55 + (17.5 \times 2.50) \implies 98.75 \text{ }^\circ\text{C}$
 2a. Using standard HQ240; $T_J = 55 + (12.5 \times 2.50) \implies 86.25 \text{ }^\circ\text{C}$
 2b. Using HQ240 with 250 LFM forced air; $T_J = 55 + (8.6 \times 2.50) \implies 76.5 \text{ }^\circ\text{C}$

For all solutions, the junction temperature is calculated as: $T_J = \text{Power} \times \Theta_{JA} + T_A$. All solutions meet the module requirement of less than 100°C, with the exception of the PQ240 package in still air. In general, depending on ambi-

ent and board temperatures conditions, and most importantly the total power dissipation, thermal enhancements -- such as forced air cooling, heat sinking, etc. may be necessary to meet the $T_{J(\text{max})}$ conditions set.

PQ/HQ Thermal Data Comparison

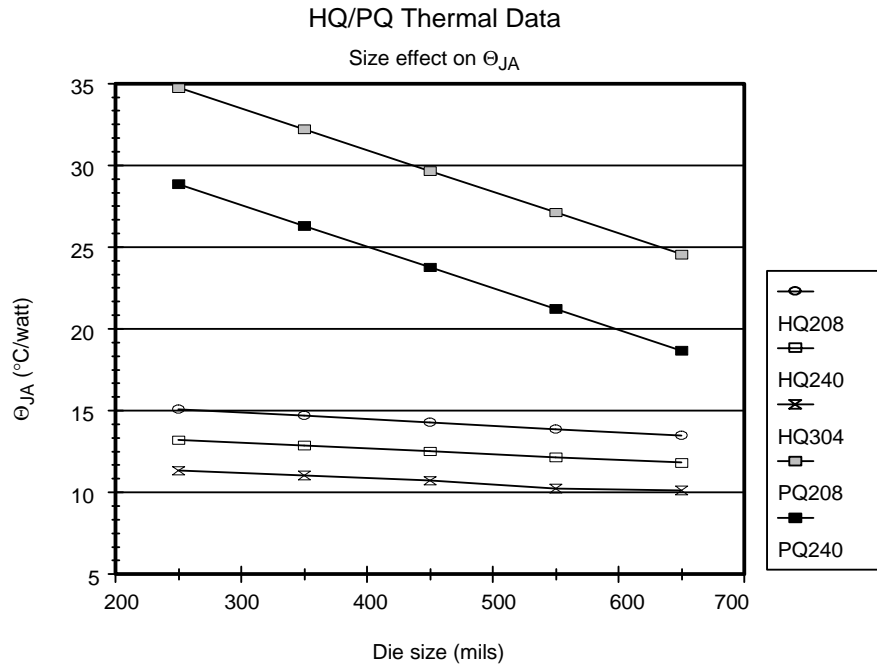

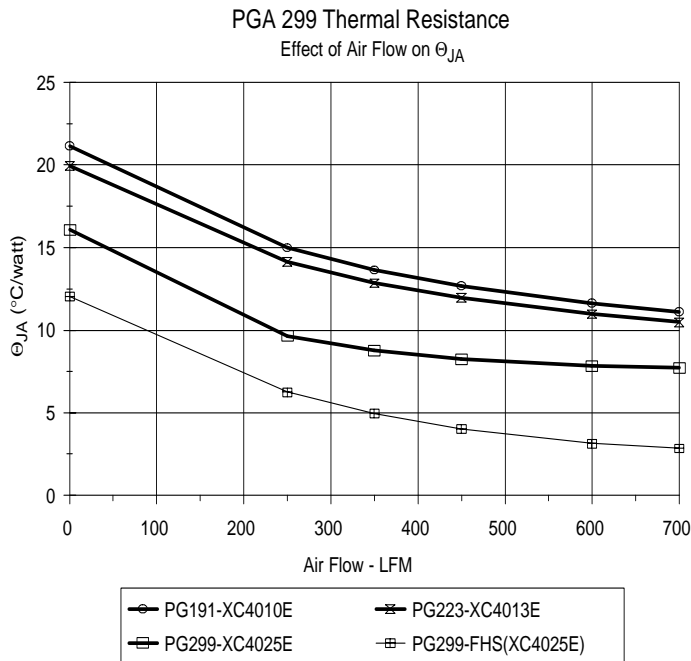
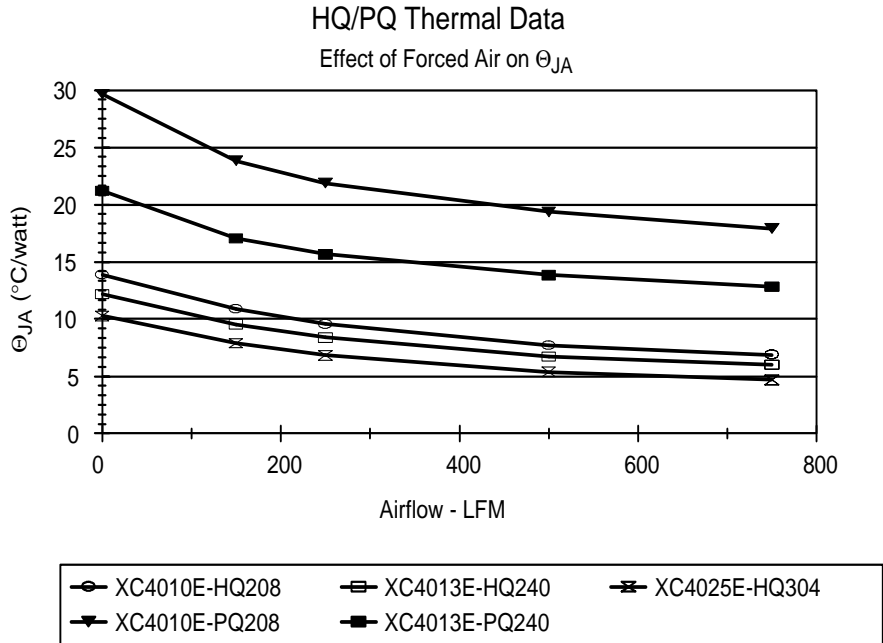

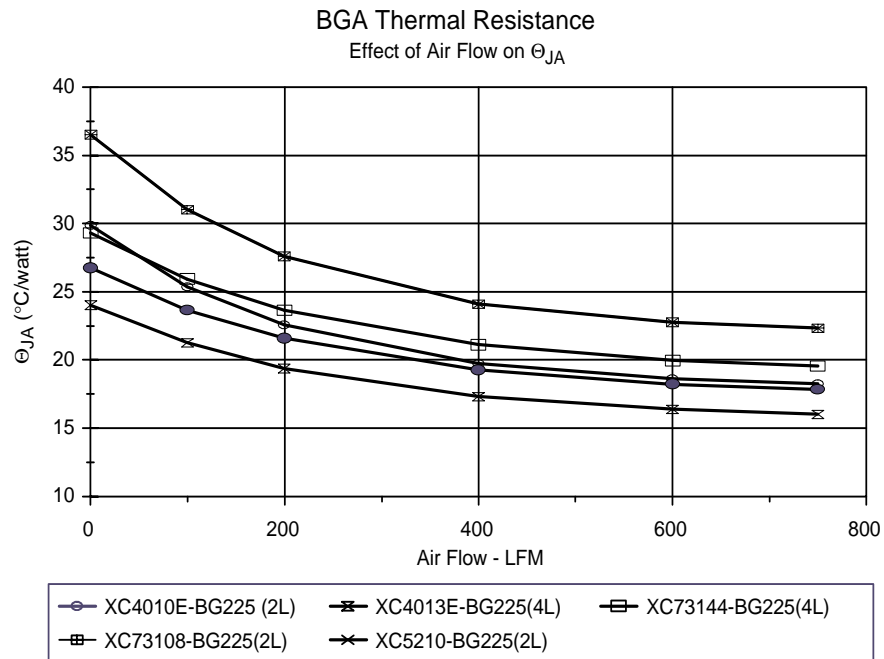
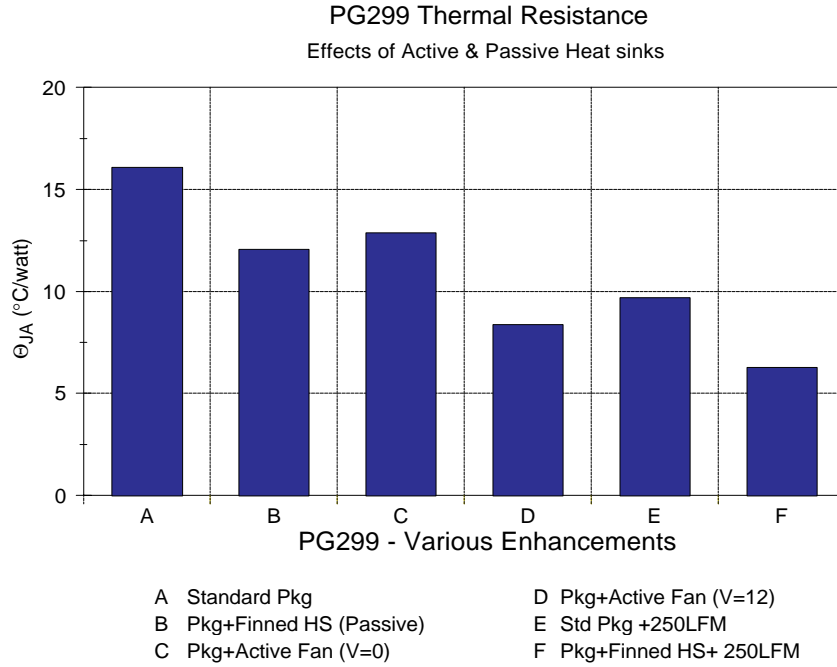

Some Power Management Options

FPGA devices are usually not the dominating power consumers in a system, and do not have a big impact on power supply designs. There are obvious exceptions. When the actual or estimated power dissipation appears to be more than the specification of the chosen package, some options can be considered. Details on the engineering designs and analysis of some of these suggested considerations may be obtained from the references listed at the end of the section. The options include:

- A Xilinx low power (L) version of the circuit in the same package. With the product and speed grade of choice, up to a 40% power reduction can be anticipated. For more information, contact the Xilinx Hotline group.
- Explore thermally enhanced package options available for the same device. As illustrated above, the HQ240 package has a thermal impedance of about 50% of the equivalent PQ240. Besides, the 240 lead, the 208 lead and the 304 lead Quad packages have equivalent heatsink enhanced versions. Typically 25% to 40% improvement in thermal performance can be expected from these heatsink enhanced packages. Most of the high gate count devices above the XC4013 level come either exclusively in heat enhanced packages or have these packages as options. If the use of a standard PQ appears to be a handicap in this respect, a move to the equivalent HQ package if available may resolve the issue. The heat enhanced packages are pin to pin compatible and they use the same board layout.
- The use of forced air is an effective way to improve thermal performance. As seen on the graphs and the calculations above, forced air (200 -- 300 LFM) can reduce junction to ambient thermal resistance by 30%.
- If space will allow, the use of finned external heatsinks can be effective. If implemented with forced air as well, the benefit can be a 40% to 50% reduction. The HQ304, all cavity down PGAs, and the BG352 with exposed heatsink lend themselves to the application of external heatsinks for further heat removal efficiency.
- Outside the package itself, the board on which the package sits can have a significant impact. Board designs may be implemented to take advantage of this. Heat flows to the outside of a board mounted package and is sunk into the board to radiate. The effect of the board will be dependent on the size and how it conducts heat. Board size, the level of copper traces on it, the number of buried copper planes all lower the junction-to-ambient thermal resistance for a package. Some of the heatsink packages with the exposed heatsink on the board side can be glued to the board with thermal compound to enhance heat removal.

References

Forced Air Cooling Application Engineering

COMAIR ROTRON
2675 Custom House Court
San Ysidro, CA 92173
1-619-661-6688

Heatsink Application Engineering

The following facilities provide heatsink solutions for industry standard packages.

AAVID Thermal Technologies

1 Kool Path
Box 400
Laconia, NH 03247-0400
1-603-528-3400

Thermalloy, Inc.

2021 W. Valley View Lane
Box 810839
Dallas, TX 75381-0839
1-214-243-4321

Wakefield Engineering, Inc.

60 Audubon Road
Wakefield MA 01880-1255
1-617-245-5900

Xilinx does not endorse these vendors nor their products. They are listed here for reference only. Any materials or services received from the vendors should be evaluated for compatibility with Xilinx components.

Package Electrical Characterization

In high-speed systems, the effects of electrical package parasitics become very critical when optimizing for system performance. Such problems as ground bounce and crosstalk can occur due to the inductance, capacitance, and resistance of package interconnects. In digital systems, such phenomena can cause logic error, delay, and reduced system speed. A solid understanding and proper usage of package characterization data during system design simulation can help prevent such problems.

Theoretical Background

There are three major electrical parameters which are used to describe the package performance: resistance, capacitance, and inductance. Also known as interconnect parasitics, they can cause many serious problems in digital systems. For example, a large resistance can cause RC & RL off-chip delays, power dissipation, and edge-rate degradation. Large capacitance can cause RC delays, crosstalk, edge-rate degradation, and signal distortion. The lead inductance, perhaps the most damaging parasitic in digital

circuitry, can cause such problems as ground bounce (also known as simultaneous switching noise or delta-I noise), RL delays, crosstalk, edge rate degradation, and signal distortion.

Ground bounce is the voltage difference between any two grounds (typically between an IC and circuit board ground) induced by simultaneously switching current through bondwire, lead, or other interconnect inductance.

When IC outputs change state, large current spikes result from charging or discharging the load capacitance. The larger the load capacitance and faster the rise/fall times, the larger the current spikes are: $I = C * dv/dt$. Current spikes through the IC pin and bondwire induces a voltage drop across the leads and bondwires: $V = L * di/dt$. The result is a momentary voltage difference between the internal IC ground and system ground, which show up as voltage spikes and unswitched outputs.

Factors that affect ground bounce:

- rise and fall times
- load capacitance
- package inductance
- number of output drivers sharing the same ground path
- device type

Analytical Formulas for Lead Inductance

1. Rectangular Leadframe/Trace (straight)

$$L_{\text{self}} = 5l \left[\ln \left(\frac{2l}{w+t} \right) + \frac{1}{2} \right] \quad \text{nH} \quad \text{(no ground)}$$

$$L_{\text{self}} = 5l \left[\ln \left(\frac{8h}{w+t} \right) + \left(\frac{w+t}{4h} \right) \right] \quad \text{nH} \quad \text{(above ground)}$$

- l = lead/trace length
- w = lead/trace width
- t = lead/trace thickness
- h = ground height
- unit = inches

2. Bondwire (gold wire)

$$L_{\text{wire}} = 5l \left[\ln \left(\frac{2l}{r} \right) - \frac{3}{4} \right] \quad \text{nH}$$

- L = wire length
- r = wire radius
- unit = inches

General Measurement Procedure

Xilinx uses the Time-Domain Reflectometry (TDR) method for parasitic inductance and capacitance measurements. The main components of a TDR setup includes: a digitizing sampling oscilloscope, a fast rise time step generator (<17 ps), a device-under-test (DUT) interface, and an impedance-profile analysis software to extract parasitic models from the TDR reflection waveforms. In this method, a voltage step is propagated down the package under test, and the incident and reflected voltage waves are monitored by the oscilloscope at a particular point on the line. The resulting characteristic impedance of the package interconnect shows the nature (resistive, inductive, and capacitive) of each discontinuity.

Package and Fixture Preparation

Before performing the measurements, the package and the DUT interface must be fixtured. Proper fixturing ensures accurate and repeatable measurements. The mechanical sample for all inductance (self & mutual) measurements are finished units with all leads shorted to the internal ground. For packages without an internal ground (i.e. QFP, PLCC, etc.) the die-paddle is used instead. The mechanical sample for all capacitance (self & mutual) measurements are finished units with all internal leads floating. The DUT interface provides a physical connection between the oscilloscope and the DUT with minimum crosstalk and probe/DUT reflection. It also provides small ground loop to minimize ground inductance of the fixture.

Inductance and Capacitance Measurement Procedure

For inductance measurements, a minimum of 25% and maximum of 50% of packages leads, including all leads that are adjacent to the lead(s) under test, are insulated from the DUT fixture ground. All other leads, except for the lead(s) under test, are grounded. This insulation forces the current to return through a low impedance path created on the opposite side of the package. It also eliminates mutual coupling from the neighboring leads. Self-inductance is measured by sending a fast risetime step waveform through the lead under test. The inductive reflection waveform through the lead and the bondwire is then obtained. This reflection waveform, which includes the inductance of the die-paddle (for QFP and PLCC-type packages) and parallel combination of leads in the return path, is the self-inductance. The parasitic effects of the return path are small enough to ignore in the context of this method. For mutual-inductance measurement, two adjacent leads are probed. A fast risetime step waveform is sent through one of the leads. The current travels through the lead/bondwire and returns by the path of the low-impedance ground. On the adjacent "quiet" lead, a waveform is induced due to mutual coupling. This waveform is measured as the mutual inductance.

For capacitance measurements, all external leads except for the lead(s) under test are grounded to the DUT fixture. For QFP, PLCC, and Power Quad-type of packages, the die-paddle and the heat slug are left floating. Self-capacitance is measured by sending a fast risetime step waveform through the lead under test. The reflection waveform from the lead, which includes the sum of all capacitive coupling with respect to the lead under test, is then measured. Appropriately, the self-capacitance can also be called the “bulk” capacitance since the measured value includes the capacitance between the lead under test and all surrounding metal, including the ground plane and the heat slug. For mutual-capacitance measurement, two adjacent leads are probed. An incident waveform is sent through one lead, and the induced waveform on the neighboring lead is measured as the mutual capacitance.

In order to de-embed the electrical parasitics of the DUT fixture and the measuring probes, the short and the open compensation waveforms are also measured after each package measurement. This procedure compensates the DUT fixture to the very tip of the probes.

Inductance & Capacitance Model Extraction

All measured reflection waveforms are downloaded to a PC running the analysis software for package parasitic model

extraction. The software uses a method called the Z-profile algorithm, or the impedance-profile algorithm, for parasitic analysis. This method translates the downloaded reflection waveforms into true impedance waveforms, from which package models for inductance and capacitance are extracted.

Data Acquisition and Package Electrical Database

Xilinx acquires electrical parasitic data only on the longest and the shortest lead/traces of the package. This provides the best and the worst case for each package type (defined by package design, lead/ball count, pad size, and vendor). For convenience, the corner interconnects are usually selected as the longest interconnect, while the center interconnects are usually selected as the shortest.

For symmetrical quad packages, all four sides of the package are measured and averaged. Three to five samples are usually measured for accuracy and continuity purposes. The average of these samples is then kept as the official measured parasitic data of that package type in the database.

Component Mass (Weight) by Package Type

Package	Description	JEDEC Outline #	Xilinx #	Mass (g)
BG225	MOLDED BGA 27 mm FULL MATRIX	MO-151-CAL	OBG0001	2.2
BG256	MOLDED BGA 27 mm SQ	MO-151-CAL	OBG0011	2.2
BG352	SUPERBGA - 35 X 35 mm PERIPHERAL	MO-151-BAR	OBG0008	7.1
BG432	SUPERBGA - 40 X 40 mm PERIPHERAL	MO-151-BAU	OBG0009	9.1
BG560	SUPERBGA - 42.5 X 42.5 mm SQ	MO-192-BAV	OBG0010	11.5
CB100	NCTB TOP BRAZE 3K VER	MO-113-AD ³	OCQ0008	10.8
CB100	NCTB TOP BRAZE 4K VER	MO-113-AD ³	OCQ0006	10.8
CB164	NCTB TOP BRAZE 3K VER	MO-113-AA-AD ³	OCQ0003	11.5
CB164	NCTB TOP BRAZE 4K VER	MO-113-AA-AD ³	OCQ0007	11.5
CB196	NCTB TOP BRAZE 4K VER	MO-113-AB-AD ³	OCQ0005	15.3
CB228	NCTB TOP BRAZE 4K VER	MO-113-AD ³	OCQ0012	17.6
DD8	.300 CERDIP PACKAGE	MO-036-AA	OPD0005	1.1
HQ160	METRIC 28 28 -.65 mm 1.6H/S DIE UP	MO-108-DDI	OPQ0021	10.8
HQ208	METRIC 28 X 28 - H/S DIE UP	MO-143-FA1	OPQ0020	10.8
HQ240	METRIC QFP 32 32 - H/S DIE UP	MO-143-GA	OPQ0019	15.0
HQ304	METRIC QFP 40 40-H/S DIE DOWN	MO-143-JA	OPQ0014	26.2
PC20	PLCC JEDEC MO-047	MO-047-AA	OPC0006	0.8
PC44	PLCC JEDEC MO-047	MO-047-AC	OPC0005	1.2
PC68	PLCC JEDEC MO-047	MO-047-AE	OPC0001	4.8
PC84	PLCC JEDEC MO-047	MO-047-AF	OPC0001	6.8
PD8	DIP .300 STANDARD	MO-001-AA	OPD0002	0.5
PG84	CERAMIC PGA CAV UP 11X11	MO-067-AC	OPG0003	7.2
PG120	CERAMIC PGA 13 X 13 MATRIX	MO-067-AE	OPG0012	11.5
PG132	CERAMIC PGA 14 X 14 MATRIX	MO-067-AF	OPG0004	11.8

Component Mass (Weight) by Package Type (Continued)

Package	Description	JEDEC Outline #	Xilinx #	Mass (g)
PG156	CERAMIC PGA 16 X 16 MATRIX	MO-067-AH	OPG0007	17.1
PG175	CERAMIC PGA 16 X 16 STD VER.	MO-067-AH	OPG0009	17.7
PG191	CERAMIC PGA 18 X 18 STD - ALL	MO-067-AK	OPG0008	21.8
PG223	CERAMIC PGA 18 X 18 TYPE	MO-067-AK	OPG0016	26.0
PG299	CERAMIC PGA 20 X 20 HEATSINK	MO-067-AK	OPG0022	37.5
PG299	CERAMIC PGA 20 X 20 TYPE	MO-067-AK	OPG0015	29.8
PG411	CERAMIC PGA 39 X 39 STAGGER	MO-128-AM	OPG0019	36.7
PG475	CERAMIC PGA 41 X 41 STAGGER	MO-128-AM	OPG0023	39.5
PG559	CERAMIC PGA 43 x 43	MO-128	OPG0025	44.50
PP132	PLASTIC PGA 14 X 14 MATRIX	MO-83-AF	OPG0001	8.1
PP175	PLASTIC PGA 16 X 16 BURIED	MO-83-AH	OPG0006	11.1
PQ100	EIAJ 14 X 20 QFP - 1.60	MO-108-CC1	OPQ0013	1.6
PQ160	EIAJ 28 X 28 .65 mm 1.60	MO-108-DD1	OPQ0002	5.8
PQ208	EIAJ 28 X 28 .5 mm 1.30	MO-143-FAI	OPQ0003	5.3
PQ240	EIAJ 32 X 32 .5 mm	MO-143-GA	OPQ0010	7.1
SO8	VERSION 1 - .150/55MIL	MO-150	OPD0006	0.1
TQ100	THIN QFP 1.4 mm thick	MS-026-BDE	OPQ0004	0.7
TQ144	THIN QFP 1.4 mm thick	MS-026-BFB	OPQ0007	1.4
TQ176	THIN QFP 1.4 mm thick	MS-026-BGA	OPQ0008	1.9
CS48	Chip Scale 7 x 7 mm, 0.8 mm ball pitch	-	OBG0012	0.2
CS144	Chip Scale 12 x 12 mm, 0.8 mm ball pitch	MO-205-BE	OBG0015	0.3
FG256	Fine Pitch BGA 17 x 17 mm, 1.0 mm ball pitch	MO-151-AAF-1	OBG0021	0.8
FG456	Fine Pitch BGA 23 x 23 mm, 1.0 mm ball pitch	MO-151-AAJ-1	OBG0019	2.1
FG556	Fine Pitch BGA 31 x 31 mm, 1.0 mm ball pitch	MO-151-AAN-1	OBG0020	3.92
FG676	Fine Pitch BGA, 27 x 27 mm, 1.0 mm ball pitch	MO-151-AAL-1	OBG0018	3.3
FG680	Fine Pitch BGA 40 x 40 mm, 1.0 mm ball pitch	MO-151-AAU-1	OBG0022	10.3
FG900	Fine Pitch BGA, 31 x 31 mm, 1.0 mm ball pitch	MO-151-AAN-1	OBG0027	4.0
FG1156	Fine Pitch BGA, 35 x 35 mm, 1.0 mm ball pitch	MO-151-AAR-1	OBG0028	5.5
VO8	THIN SOIC-II	N/A	OPD0007	0.1
VQ44	THIN QFP 1.0 thick	MS-026-ACB	OPQ0017	0.4
VQ64	THIN QFP 1.0 thick	MS-026-ACD	OPQ0009	0.5
VQ100	THIN QFP 1.0 thick	MS-026-AED	OPQ0012	0.6

- Notes:
1. Data represents average values for typical packages with typical devices. The accuracy is between 7% to 10%.
 2. More precise numbers (below 5% accuracy) for specific devices may be obtained from Xilinx through a factory representative or by calling the Xilinx Hotline.
 3. Tie-bar details are specific to Xilinx package. Lead width minimum is 0.056".

Xilinx Thermally Enhanced Packaging

The Package Offering

Xilinx Code	Body (mm)	THK (mm)	Mass (gm)	Heatsink Location	JEDEC No.	Xilinx No.
HQ160	28x28	3.40	10.8	DOWN	MO-108-DD1	OPQ0021
HQ208	28x28	3.40	10.0	DOWN	MO-143-FA	OPQ0020
HQ240	32x32	3.40	15.0	DOWN	MO-143-GA	OPQ0019
HQ304	40x40	3.80	26.2	TOP	MO-143-JA	OPQ0014

Overview

Xilinx offers thermally enhanced quad flat pack packages on certain devices. This section discusses the performance and usage of these packages (designated HQ). In summary:

- The HQ-series and the regular PQ packages conform to the same JEDEC drawings.
- The HQ and PQ packages use the same PCB land patterns.
- The HQ packages have more mass
- Thermal performance is better for the HQ packages

Where and When Offered

- HQ packages are offered as the thermally enhanced equivalents of PQ packages. They are used for high gate count or high I/O count devices in packages, where heat dissipation without the enhancement may be a handicap for device performance. Such devices include XC4013E, XC4020E, XC4025E, and XC5215.
- They are also being used in place of MQUAD (MQ) packages of the same lead count for new devices.
- The HQ series at the 240 pin count level or below are offered with the heatsink at the bottom of the package. This was done to ensure pin to pin compatibility with the existing PQ and MQ packages.
- At the 304 pin count level, the HQ is offered with the heatsink up. This arrangement offers a better potential for further thermal enhancement by the designer.

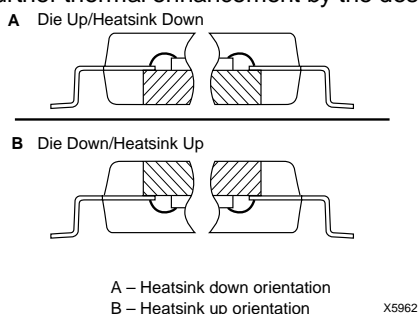

Mass Comparison

Because of the copper heatsink, the HQ series of packages are about twice as heavy as the equivalent PQ. Here is a quick comparison.

	HQ (gm)	PQ (gm)
160 Pin	10.8	5.8
208 Pin	10.8	5.3
240 Pin	15.0	7.1
304 Pin	26.2	N/A

Thermal Data for the HQ

The data for individual devices may be obtained from Xilinx.

	HQ Θ_{JA} ($^{\circ}\text{C/Watt}$)	PQ Θ_{JA} ($^{\circ}\text{C/watt}$)
160 Pin	13.5-14.5	20.5-38.5
208 Pin	14-15	26-35
240 Pin	12-13	19-28
304 Pin	10-11	N/A

Note: Θ_{JC} is typically between 1 and 2 $^{\circ}\text{C/Watt}$ for HQ and MQ Packages. For PQ's, it is between 2 and 7 $^{\circ}\text{C/Watt}$.

	HQ Θ_{JA} ($^{\circ}\text{C/watt}$)	PQ Θ_{JA} ($^{\circ}\text{C/watt}$)
160 Pin	9-10	15-28.5
208 Pin	9-10	14-26
240 Pin	8-9	11-21
304 Pin	6.5-8	N/A

Other Information

- Leadframe: Copper EFTEC-64 or C7025
- Heat Slug: Copper - Nickel plated → Heatsink metal is Grounded
- Lead Finish 85/15 Sn/Pb 300 microinches minimum
- D/A material - Same as PQ; Epoxy 84-1LMISR4
- Mold Cpd. Same as PQ - EME7304LC
- Packed in the same JEDEC trays

Moisture Sensitivity of PSMCs

Moisture Induced Cracking During Solder Reflow

The surface mount reflow processing step subjects the Plastic Surface Mount Components (PSMC) to high thermal exposure and chemicals from solder fluxes and cleaning fluids during user's board mount assembly. The plastic mold compounds used for device encapsulation are, universally, hygroscopic and absorb moisture at a level determined by storage environment and other factors. Entrapped moisture can vaporize during rapid heating in the solder reflow process generating internal hydrostatic pressure. Additional stress is added due to thermal mismatch, and the Thermal Coefficient of Expansion (TCE) of plastic, metal lead frame, and silicon die. The resultant pressure may be sufficient to cause delamination within the package, or worse, an internal or external crack in the plastic package. Cracks in the plastic package can allow high moisture penetration, inducing transport of ionic contaminants to the die surface and increasing the potential for early device failure.

How the effects of moisture in plastic packages and the critical moisture content result in package damage or failure is a complex function of several variables. Among them are package construction details -- materials, design, geometry, die size, encapsulant thickness, encapsulant properties, TCE, and the amount of moisture absorbed. The PSMC moisture sensitivity has, in addition to package cracking, been identified as a contributor to delamination-related package failure artifacts. These package failure artifacts include bond lifting and breaking, wire neckdown, bond cratering, die passivation, and metal breakage.

Because of the importance of the PSMC moisture sensitivity, both device suppliers and device users have ownership and responsibility. The background for present conditions, moisture sensitivity standardized test and handling procedures have been published by two national organizations. Users and suppliers are urged to obtain copies of both documents (listed below) and use them rigorously. Xilinx adheres to both.

- JEDEC STANDARD JESD22-A112. Test Method A112 “Moisture-Induced Stress Sensitivity for Plastic Surface Mounted Devices”.
Available through Global Engineering Documents
Phone: USA and Canada 800-854-7179, International 1-303-792-2181

- IPC Standard IPC-SM-786A “Procedures for Characterizing and Handling of Moisture/Reflow Sensitive ICs”.

Available through IPC
Phone: 1-708-677-2850

None of the previously stated or following recommendations apply to parts in a socketed application. For board mounted parts careful handling by the supplier and the user is vital. Each of the above publications has addressed the sensitivity issue and has established 6 levels of sensitivity (based on the variables identified). A replication of those listings, including the preconditioning and test requirements, and the factory floor life conditions for each level are outlined in [Table 5](#). Xilinx devices are characterized to their proper level as listed. This information is conveyed to the user via special labeling on the Moisture Barrier Bag (MBB).

In [Table 5](#), the level number is entered on the MBB prior to shipment. This establishes the user’s factory floor life conditions as listed in the time column. The soak requirement is the test limit used by Xilinx to determine the level number. This time includes manufacturer’s exposure time or the time it will take for Xilinx to bag the product after baking.

Table 5: Package Moisture Sensitivity Levels per J-STD-020

Level	Factory Floor Life		Soak Requirements (Preconditioning)			
	Conditions	Time	Time			Conditions
1	≤30°C / 90% RH	Unlimited	168 hours			85°C / 85% RH
2	≤30°C / 60% RH	1 year	168 hours			85°C / 60% RH
			Time (hours)			
			X +	Y =	Z	
3	≤30°C / 60% RH	168 hours	24	168	192	30°C / 60% RH
4	≤30°C / 60% RH	72 hours	24	72	96	30°C / 60% RH
5	≤30°C / 60% RH	24/28 hours	24	24/48	48/72	30°C / 60% RH
6	≤30°C / 60% RH	6 hours	0	6	6	30°C / 60% RH

Notes: X =Default value of semiconductor manufacturer’s time between bake and bag. If the semiconductor manufacturer’s actual time between bake and bag is different from the default value, use the actual time.
Y = Floor life of package after it is removed from dry pack bag.
Z = Total soak time for evaluation.

Factory Floor Life

Factory floor life conditions for Xilinx devices are clearly stated on MBB containing moisture sensitive PSMCs. These conditions have been ascertained by following Test Methods outlined in JEDEC JESD22-A112 and are replicated in [Table 5](#). If factory floor conditions are outside the stated environmental conditions (30°C/90% RH for level 1, and 30°C/60% RH for Levels 2-6) or if time limits have been exceeded, then recovery can be achieved by baking the devices before the reflow step. Identified in the next section are two acceptable bake schedules. Either can be used for recovery to the required factory floor level.

Dry Bake Recommendation and Dry Bag Policy

Xilinx recommends, as do the mentioned publications and other industry studies, that all moisture sensitive PSMCs be baked prior to use in surface mount applications, or comply strictly with requirements as specified on the MBB. Tape and Reeled parts are universally dry packed. Level 1 parts are shipped without the need for, or use of, an MBB.

Two bake schedules have been identified as acceptable and equivalent. The first is 24 hours in air at 125°C., in shipping media capable of handling that temperature. The second bake schedule is for 192 hours in a controlled atmosphere of 40°C, equal to or less than 5% RH.

Dry Devices are sealed in special military specification Moisture Barrier Bags (MBB). Enough desiccant pouches are enclosed in the MBB to maintain contents at less than 20% RH for up to 12 months from the date of seal. A reversible Humidity Indicator Card (HIC) is enclosed to monitor the internal humidity level. The loaded bag is then sealed shut under a partial vacuum with an impulse heat sealer.

Artwork on the bags provides storage, handling and use information. There are areas to mark the seal date, quantity, and moisture sensitivity level and other information. The following paragraphs contain additional information on handling PSMCs.

Handling Parts in Sealed Bags

Inspection

Note the seal date and all other printed or hand entered notations. Review the content information against what was ordered. Thoroughly inspect for holes, tears, or punctures that may expose contents. Xilinx strongly recommends that the MBB remain closed until it reaches the actual work sta-

tion where the parts will be removed from the factory shipping form.

Storage

The sealed MBB should be stored, unopened, in an environment of not more than 90% RH and 40°C. The enclosed HIC is the only verification to show if the parts have been exposed to moisture. Nothing in part appearance can verify moisture levels.

Expiration Date

The seal date is indicated on the MBB. The expiration date is 12 months from the seal date. If the expiration date has been exceeded or HIC shows exposure beyond 20% upon opening the bag bake the devices per the earlier stated bake schedules. The three following options apply after baking:

Use the devices within time limits stated on the MBB.

Reseal the parts completely under a partial vacuum with an impulse sealer (hot bar sealer) in an approved MBB within 12 hours, using fresh desiccant and HIC, and label accordingly. Partial closures using staples, plastic tape, or cloth tape are unacceptable.

Store the out-of-bag devices in a controlled atmosphere at less than 20% RH. A desiccator cabinet with controlled dry air or dry nitrogen is ideal.

Other Conditions

Open the MBB when parts are to be used. Open the bag by cutting across the top as close to the seal as possible. This provides room for possible resealing and adhering to the reseal conditions outlined above. After opening, strictly adhere to factory floor life conditions to ensure that devices are maintained below critical moisture levels.

Bags opened for less than one hour (strongly dependent on environment) may be resealed with the original desiccant. If the bag is not resealed immediately, new desiccant or the old one that has been dried out may be used to reseal, **if the factory floor life has not been exceeded**. Note that factory floor life is cumulative. Any period of time when MBB is opened must be added to all other opened periods.

Both the desiccant pouches and the HIC are reversible. Restoration to dry condition is accomplished by baking at 125°C for 10-16 hours, depending on oven loading conditions.

Tape and Reel

Xilinx offers a tape & reel packing for PLCC, BGA, QFP, and SO packages. The packing material is made of black conductive Polystyrene and protects the packages from mechanical and electrical damage. The reel material provides a suitable medium for pick and place equipment.

The tape & reel packaging consists of a pocketed carrier tape, sealed with a protective cover. The device sits on pedestals (for PLCC, QFP packages) to protect the leads from mechanical damage. All devices loaded into the tape carriers are baked, lead scanned before the cover tape is attached and sealed to the carrier. In-line mark inspection for mark quality and package orientation is used to ensure shipping quality.

Benefits

- Increased quantity of devices per reel versus tubes improves cycle time and reduces the amount of time to index spent tubes.
- Tape & reel packaging enables automated pick and place board assembly.
- Reels are uniform in size enabling equipment flexibility.
- Transparent cover tape allows device verification and orientation.
- Anti-static reel materials provides ESD protection.
- Carrier design include a pedestal to protect package leads during shipment.
- Bar code labels on each reel facilitate automated inventory control and component traceability.
- All tape & reel shipments include desiccant pouches and humidity indicators to insure products are safe from moisture.
- Compliant to Electronic Industries Association (EIA) 481.

Material and Construction

Carrier Tape

- The pocketed carrier Tape is made of conductive polystyrene material, or equivalent, with a surface resistivity level of less than 106 ohms per square inch.
- Devices are loaded 'live bug' or leads down, into a device pocket.

- Each carrier pocket has a hole in the center for automated sensing of whether a unit is in the pocket or not.
- Sprocket holes along the edge of the carrier tape enable direct feeding into an automated board assembly equipment.

Cover Tape

- An anti-static, transparent, polyester cover tape, with heat activated adhesive coating, sealed to the carrier edges to hold the devices in the carrier pockets.
- Surface resistivity on both sides is less than 1011 ohms per square inch.

Reel

- The reel is made of anti-static Polystyrene material. The loaded carrier tape is wound onto this conductive plastic reel.
- A protective strip made of conductive Polystyrene material is placed on the outer part of the reel to protect the devices from external pressure in shipment.
- Surface resistivity is less than 1011 ohms per square inch.
- Device loading orientation is in compliance with EIA Standard 481.

Bar Code Label

- The bar code label on each reel provides customer identification, device part number, date code of the product and quantity in the reel.
- Print quality are in accordance with ANSI X3.182-1990 Bar Code Print Quality Guidelines. Presentation of Data on labels are EIA-556-A compliant.
- The label is an alphanumeric, medium density Code 39 labels.
- This machine-readable label enhances inventory management and data input accuracy.

Shipping Box

- The shipping container for the reels are in a 13" x 13" x 3" C-flute, corrugated, # 3 white 'pizza' box, rated to 200 lb test.

Table 6: Tape & Reel Packaging

Package Type	Pin Count	Carrier Width	Cover Width	Pitch	Reel Size	Qty per Reel
PLCC (Plastic Leaded Chip Carrier)	20	16 mm	13.3 mm	12 mm	7 inch	250
	20	16 mm	13.3 mm	12 mm	13 inch	750
	44	32 mm	25.5 mm	24 mm	13 inch	500
	68	44 mm	37.5 mm	32 mm	13 inch	250
	84	44 mm	37.5 mm	36 mm	13 inch	250
SO (Plastic Small Outline)	8	12 mm	9.2 mm	8 mm	7 inch	750

Table 6: Tape & Reel Packaging

Package Type	Pin Count	Carrier Width	Cover Width	Pitch	Reel Size	Qty per Reel
QFP (Plastic Quad Flat Pack) PQ, VQ, TQ, HQ	100	44 mm	37.5 mm	32 mm	13 inch	250
	160	44 mm	37.5 mm	40 mm	13 inch	200
BGA (Plastic Ball Grid Array)	225/256	44 mm	37.5 mm	32 mm	13 inch	500
SBGA	352/432/560	56 mm	49.5 mm	40,48,48 mm	13 inch	200

- Notes:
1. A minimum of 230mm of empty pockets are provided at the beginning (leader) of each reel.
 2. A minimum of 160mm of empty pockets are provided at the end (trailer) of each reel.
 3. Tape Leader/Trailer requirements are in compliance to EIA Standards 481.
 4. Peel Strength between 20 and 120 grams ensures consistency during de-reeling operations and is compliant to EIA Standard 481.
 5. Each reel is subject to peel back strength tests.
 6. For packages not listed above, please contact your Xilinx sales representative for updated information.

Standard Bar Code Label Locations

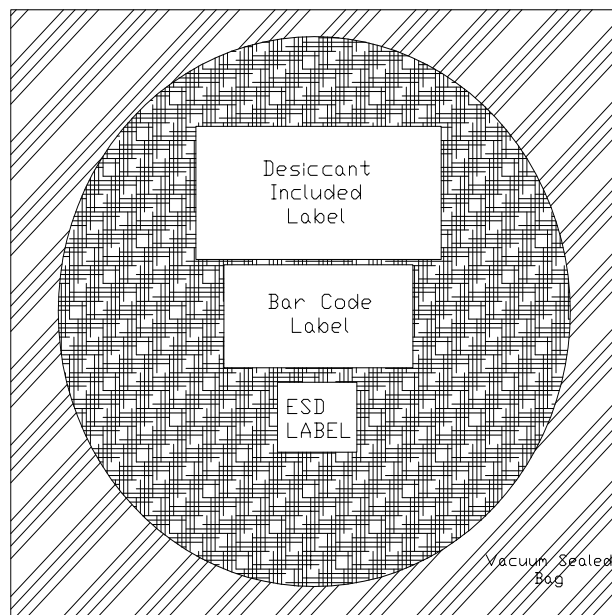
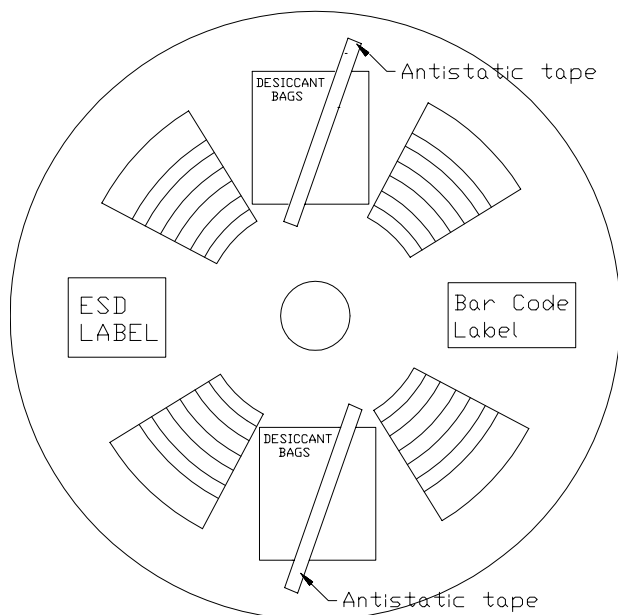

Reflow Soldering Process Guidelines

To implement and control the production of surface mount assemblies, the dynamics of the solder reflow process and how each element of the process is related to the end result must be thoroughly understood.

The primary phases of the reflow process are as follows:

1. Melting the particles in the solder paste
2. Wetting the surfaces to be joined
3. Solidifying the solder into a strong metallurgical bond

The sequence of five actions that occur during this process is shown in Figure 4.

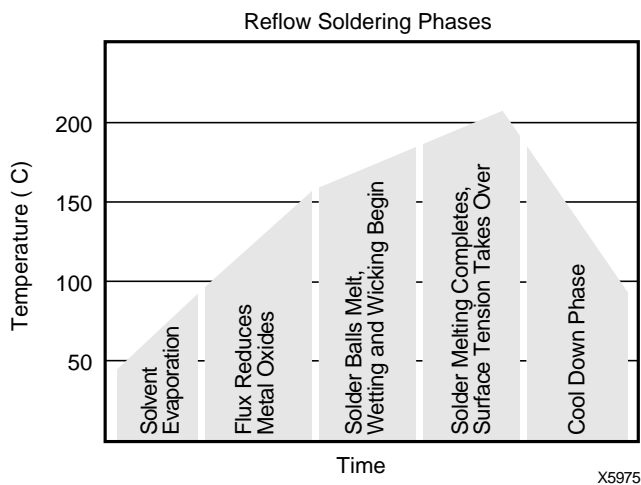

Figure 4: Soldering Sequence

Each phase of a surface mount reflow profile has min/max limits that should be viewed as a process window. The process requires a careful selection and control of the materials, geometries of the mating surfaces (package footprint vs. PCB land pattern geometries) and the time temperature of the profile. If all of the factors of the process are sufficiently optimized, there will be good solder wetting and fillet formation (between component leads and the land patterns on the substrate). If factors are not matched and optimized there can be potential problems as summarized in Figure 5.

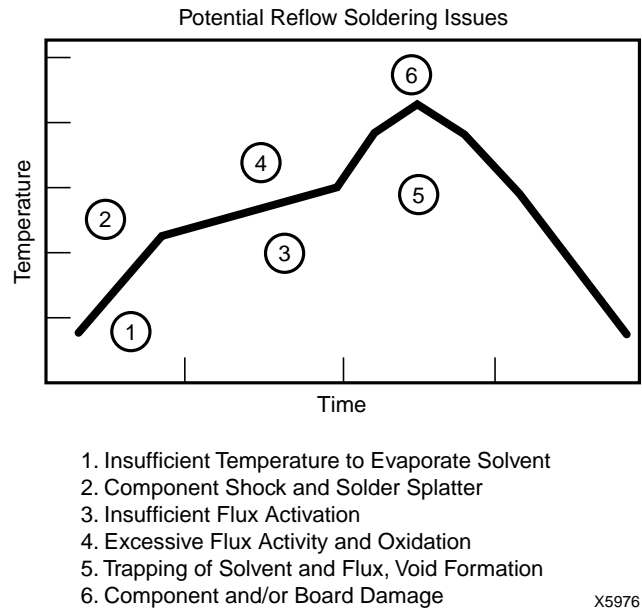

Figure 5: Soldering Problems Summary

Figure 6 and Figure 7 show typical conditions for solder reflow processing using IR/Convection or Vapor Phase. Both IR and Convection furnaces are used for BGA assembly. The moisture sensitivity of Plastic Surface Mount Components (PSMCs) must be verified prior to surface mount flow. See the preceding sections for a more complete discussion on PSMC moisture sensitivity.

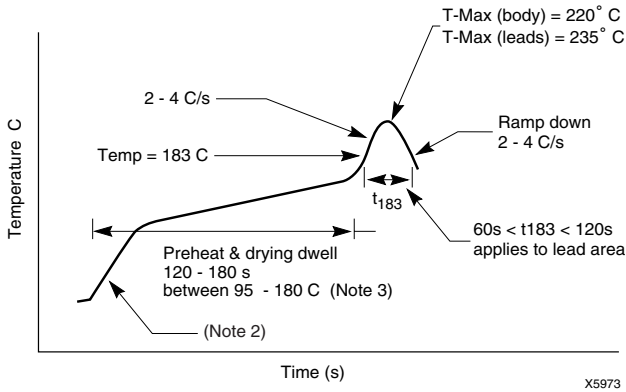

Figure 6: Typical Conditions for IR Reflow Soldering

Notes:

1. Max temperature range = 220°C-235°C (leads)
Time at temp 30-60 seconds
2. Preheat drying transition rate 2-4°C/s
3. Preheat dwell 95-180°C for 120-180 seconds
4. IR reflow shall be performed on dry packages

The IR process is strongly dependent on equipment and loading differences. Components may overheat due to lack of thermal constraints. Unbalanced loading may lead to significant temperature variation on the board. This guideline is intended to assist users in avoiding damage to the components; the actual profile should be determined by the users using these guidelines.

The peak reflow temperature of the PSMC body should not be more than 220° C in order to avoid internal package delamination. For multiple BGAs in a single board, it is recommended to check all BGA sites for varying temperatures because of differences in surrounding components.

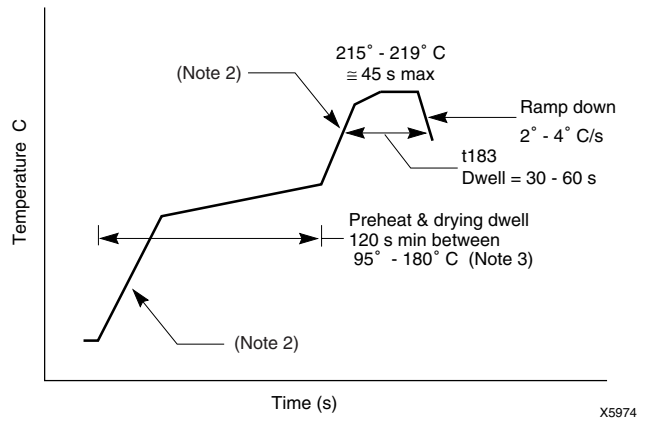

Figure 7: Typical Conditions for Vapor Phase Reflow Soldering

Notes:

1. Solvent - FC5312 or equivalent - ensures temperature range of leads @ 215-219°C
2. Transition rate 4-5°C/s
3. Dwell is intended for partial dryout and reduces the difference in temperature between leads and PCB land patterns.
4. These guidelines are for reference. They are based on laboratory runs using dry packages. It is recommended that actual packages with known loads be checked with the commercial equipment prior to mass production.

Sockets

Table 7 lists manufacturers known to offer sockets for Xilinx Package types. This summary does not imply an endorse-

ment by Xilinx. Each user has the responsibility to evaluate and approve a particular socket manufacturer.

Table 7: Socket Manufacturers

Manufacturer	Packages					
	DIP SO VO	PC WC	PQ HQ TQ VQ	PG PP	CB	BG CG
AMP Inc. 470 Friendship Road Harrisburg, PA 17105-3608 (800) 522-6752	X	X		X		
Augat Inc. 452 John Dietsch Blvd. P.O. Box 2510 Attleboro Falls, MA 02763-2510 (508) 699-7646	X	X		X		
McKenzie Socket Division 910 Page Avenue Fremont, CA 94538 (510) 651-2700	X	X		X		
3M Textool 6801 River Place Blvd. Austin, TX 78726-9000 (800) 328-0411 (612) 736-7167				X	X	X
Wells Electronics 1701 South Main Street South Bend, IN 46613-2299 (219) 287-5941				X		
Yamaichi Electronics Inc. 2235 Zanker Road San Jose, CA 95131 (408) 456-0797		X	X	X	X	

Package Drawings

Ceramic DIP Package - DD8	CD-ROM
Plastic DIP Package - PD8	CD-ROM
SOIC and TSOP Packages - SO8, VO8	CD-ROM
SOIC Package - SO20	CD-ROM
SOIC Package - SO24	CD-ROM
PLCC Packages - PC20, PC28, PC44, PC68, PC84	CD-ROM
Ceramic Leaded Chip Carrier Package - CC44	CD-ROM
Ball Chip Scale Package - CS48	CD-ROM
Ball Chip Scale Package - CS144	CD-ROM
Ball Chip Scale Package - CS280	CD-ROM
Ball Chip Scale (0.5 mm pitch) Package - CP56	CD-ROM
VQFP Packages - VQ44, VQ64, VQ100	CD-ROM
TQFP/HTQFP Packages - TQ100, TQ144, TQ176, HT100, HT144, HT176	CD-ROM
TQFP Package - TQ128	CD-ROM
TQFP Package - TQ160	CD-ROM
PQ/HQFP Packages - PQ100, HQ100	CD-ROM
PQ/HQFP Packages - PQ44, PQ160, PQ208, PQ240, HQ160, HQ208, HQ240	CD-ROM
PQ/HQFP Packages - PQ304, HQ304	CD-ROM
BGA Package - BG225	CD-ROM
BGA Package - BG256	CD-ROM
BGA Packages - BG352, BG432	CD-ROM
BGA Package - BG492	CD-ROM
BGA Package - BG560	CD-ROM
Ceramic PGA Packages - PG68, PG84	CD-ROM
Ceramic PGA Packages - PG120, PG132, PG156	CD-ROM
Ceramic PGA Package - PG175	CD-ROM
Ceramic PGA Package - PG191	CD-ROM
Ceramic PGA Packages - PG223, PG299	CD-ROM
Ceramic PGA Package - PG411	CD-ROM
Ceramic PGA Package - PG475	CD-ROM
Ceramic PGA Package - PG559	CD-ROM
Ceramic Brazed QFP Package - CB100 (XC3000 Version)	CD-ROM
Ceramic Brazed QFP Package - CB164 (XC3000 Version)	CD-ROM
Ceramic Brazed QFP Packages - CB100, CB164, CB196 (XC4000 Version)	CD-ROM
Ceramic Brazed QFP Package - CB228	CD-ROM
Ball Fine Pitch Package - FG256	CD-ROM
Ball Fine Pitch Package - FG456	CD-ROM
Ball Fine Pitch Package - FG676	CD-ROM
Ball Fine Pitch Package - FG680	CD-ROM
Ball Fine Pitch Package - FG860	CD-ROM
Ball Fine Pitch Package - FG900	CD-ROM
Ball Fine Pitch Package - FG1156	CD-ROM